

Ages 8+  
84895

INDUSTRIAL AUTOMATION

# R2-D2

Official Astromech Droid  
**OPERATION MANUAL**

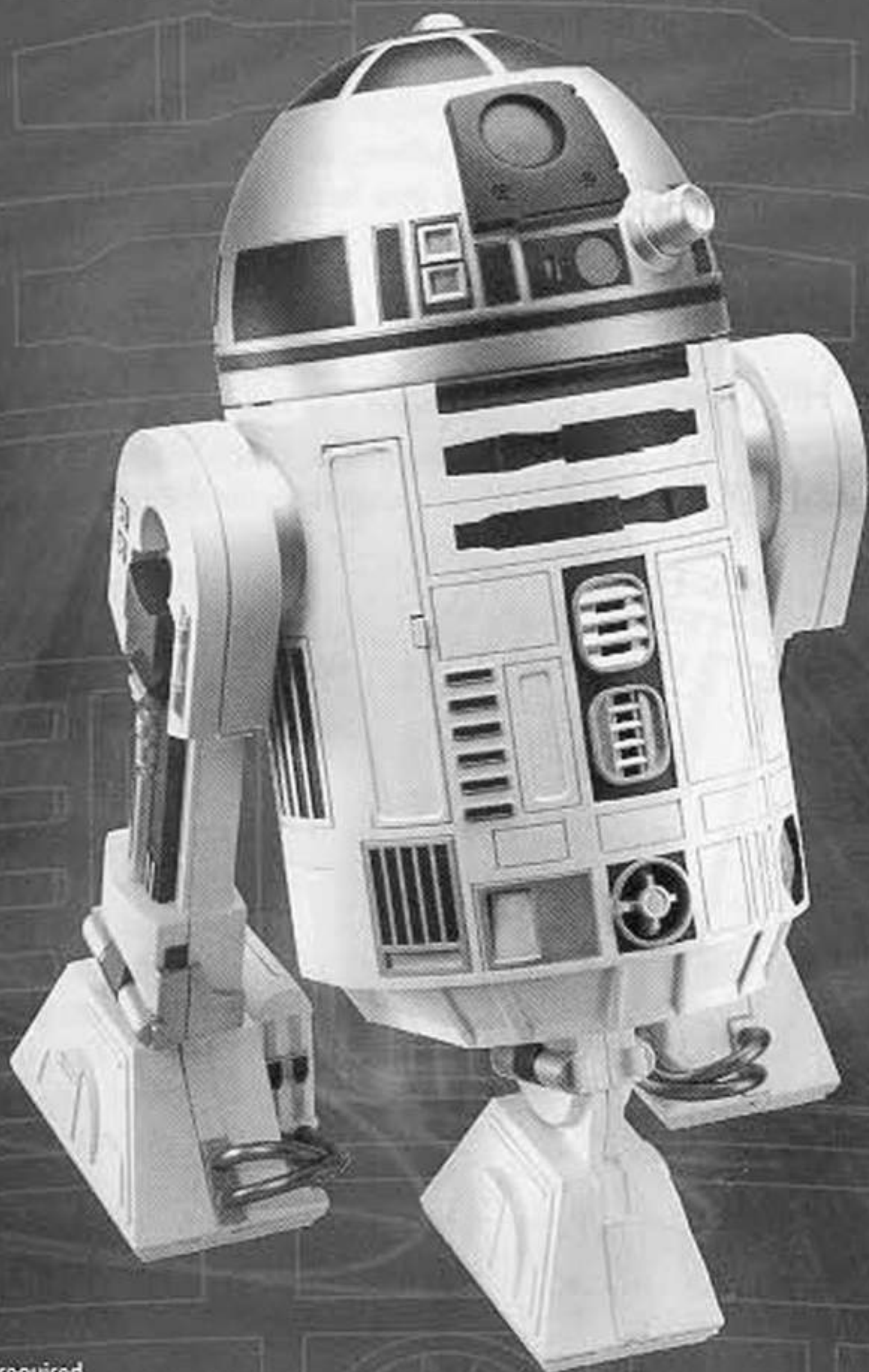

Distributed  
on Earth by:



Some assembly required.  
Requires 4 "D" batteries and 4 "AA" alkaline batteries (not included).  
Phillips screwdriver (not included) required to insert batteries.

# TABLE OF CONTENTS

Introduction . . . . .	Page 2
Assembly and Batteries . . . . .	Page 3-4
Begin Operation . . . . .	Page 5
Getting Started . . . . .	Page 6
Detailed Description . . . . .	Page 7-8
Companion Mode . . . . .	Page 7-8
Game Play with R2 . . . . .	Page 9
Navigating R2 . . . . .	Page 10-11
R2 On His Own . . . . .	Page 12
Troubleshooting . . . . .	Page 12
Using R2-D2's Utility Arm . . . . .	Page 13
Tech Specs . . . . .	Page 14

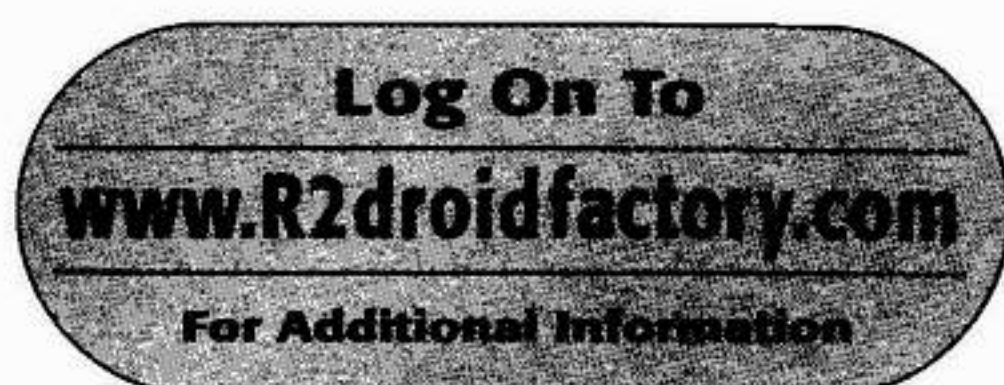



# R2-D2™

## CONGRATULATIONS!

*You are a proud owner of R2-D2, an R2-series astromech utility droid from Industrial Automaton, the galaxy's finest maker of service automatons, and distributed here on Earth by Hasbro. This droid is ready to obey certain commands, play games, and assist you on your Jedi missions.*

*This particular R2 unit comes from the peaceful world of Naboo, where he and a team of astromechs served Queen Amidala aboard her Royal Starship. R2-D2 has seen and taken part in many amazing adventures. He fought valiantly alongside both Anakin and Luke Skywalker, aided the Old Republic during the clone wars, and was instrumental to the Rebellion against the Empire during the Galactic Civil War.*

R2-D2 (or, alternately, Artoo Detoo) has been newly programmed at our state-of-the-art factory to be your devoted helper and friend: to obey your commands, to act as your room sentry and guard, and to play fun games with you and your friends!

R2's vocabulary of electronic beeps and whistles doesn't stop this droid from trying to communicate with human masters; he understands certain commands, and usually manages to get his points across, too! To get started, simply follow the instructions of this manual. Please be aware that R2 is an especially feisty astromech; when not treated well, he will let you know about it! But if you treat R2-D2 with the same loyalty and dedication that he will give to you, this little droid may help you to follow in the footsteps of the illustrious Jedi masters!

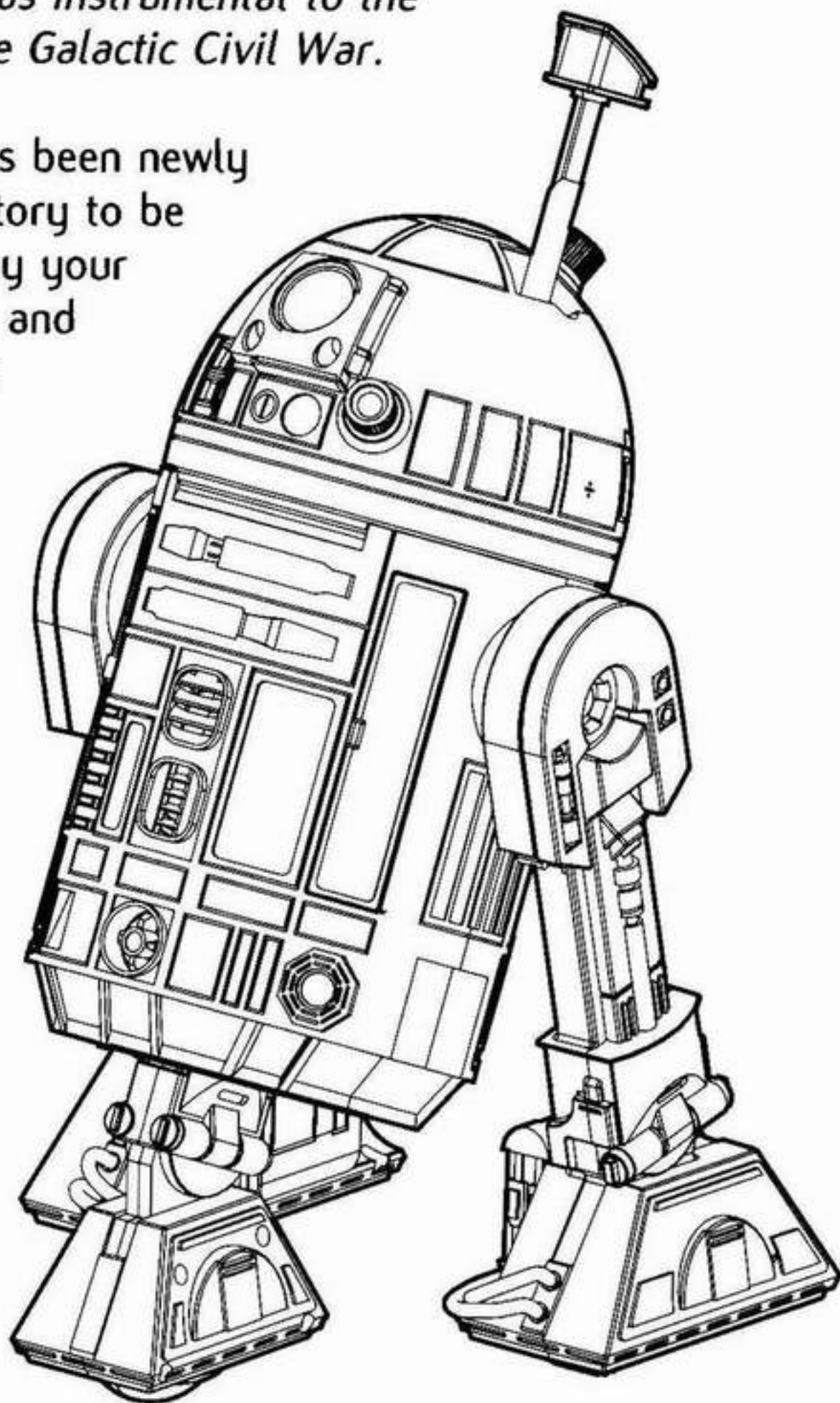



# ASSEMBLY AND BATTERIES

R2-D2 will be ready for action after the following power up procedures:

## DROID ASSEMBLY:

- 1.) Snap the head/projector piece onto the main unit.
- 2.) Snap the side legs onto each side of the main unit.
- 3.) As an option, you may also remove the sensor array from the top of R2's dome and use the included telescope piece to extend it from his head.

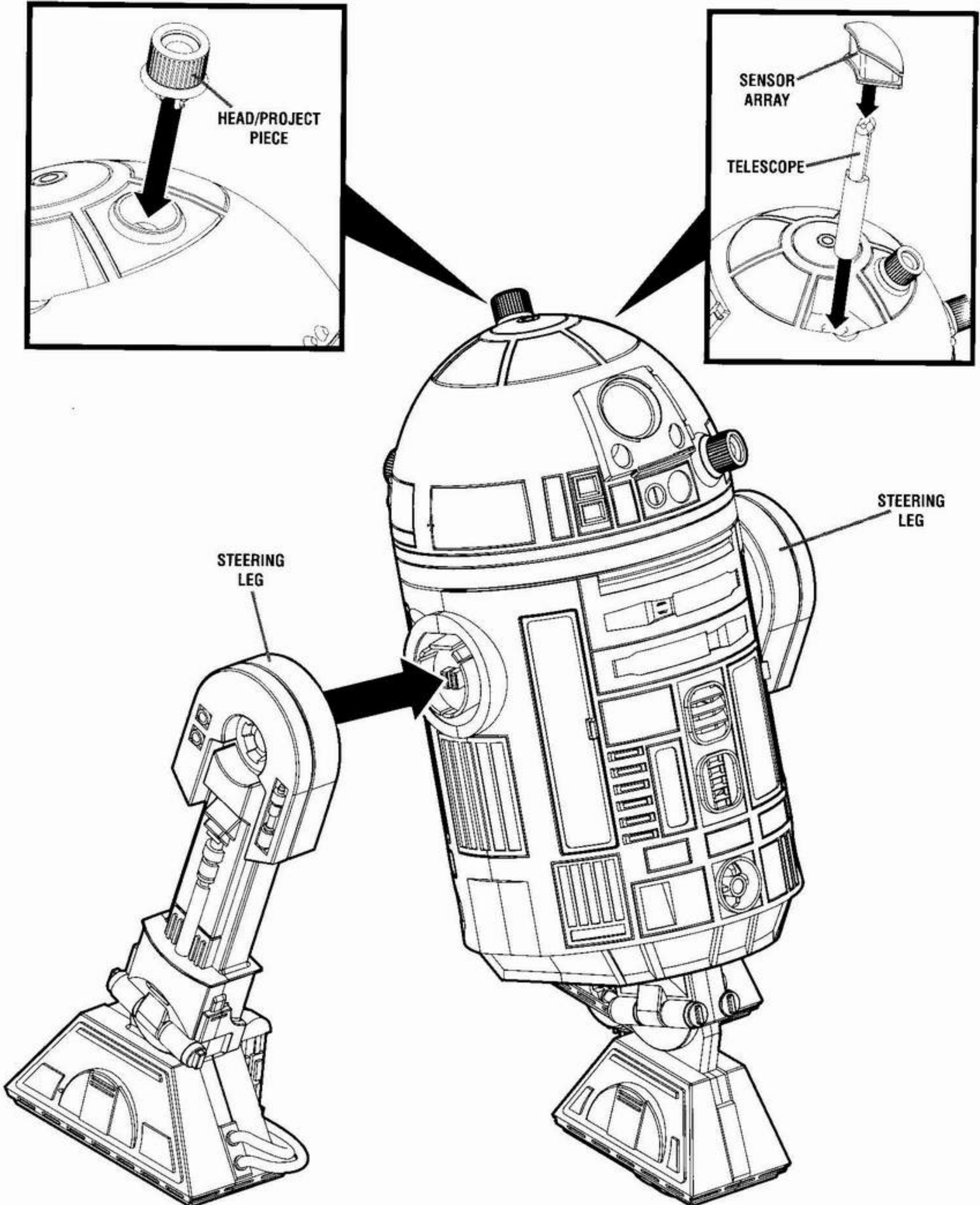



## INSTALLING BATTERIES:

- 1.) Use a Phillips screwdriver to loosen the two captive screws that secure the battery door in back, and remove the door.
- 2.) Open the compartment door. Insert four "AA" batteries into the compartment. Close the compartment door, then insert four "D" batteries on top as shown. (Re-chargeable batteries, such as NiCd or NiMH, will work well for the "D" cells, but are not necessary for the "AA" batteries.)
- 3.) Replace the battery door, and securely fasten the screws.

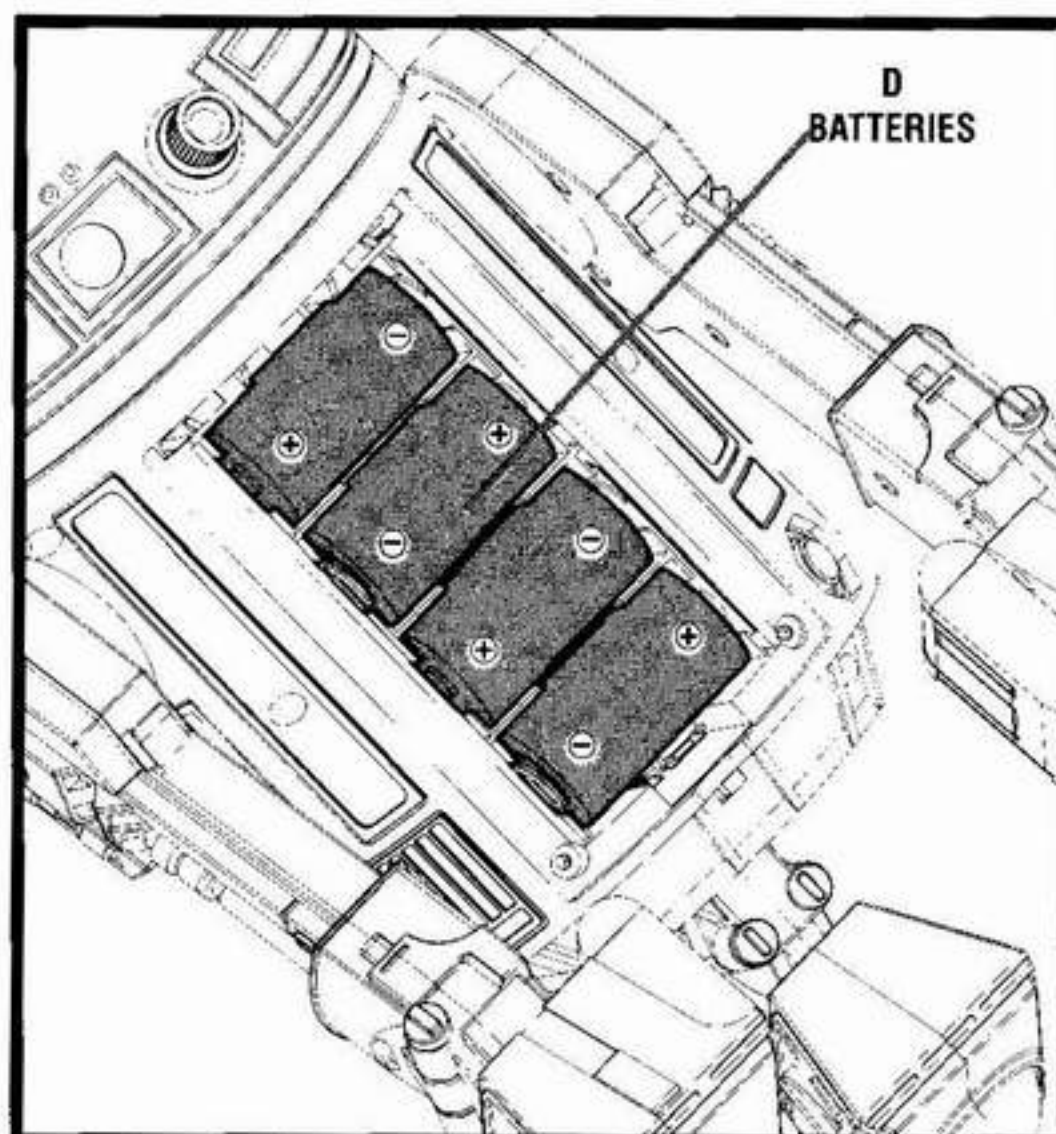
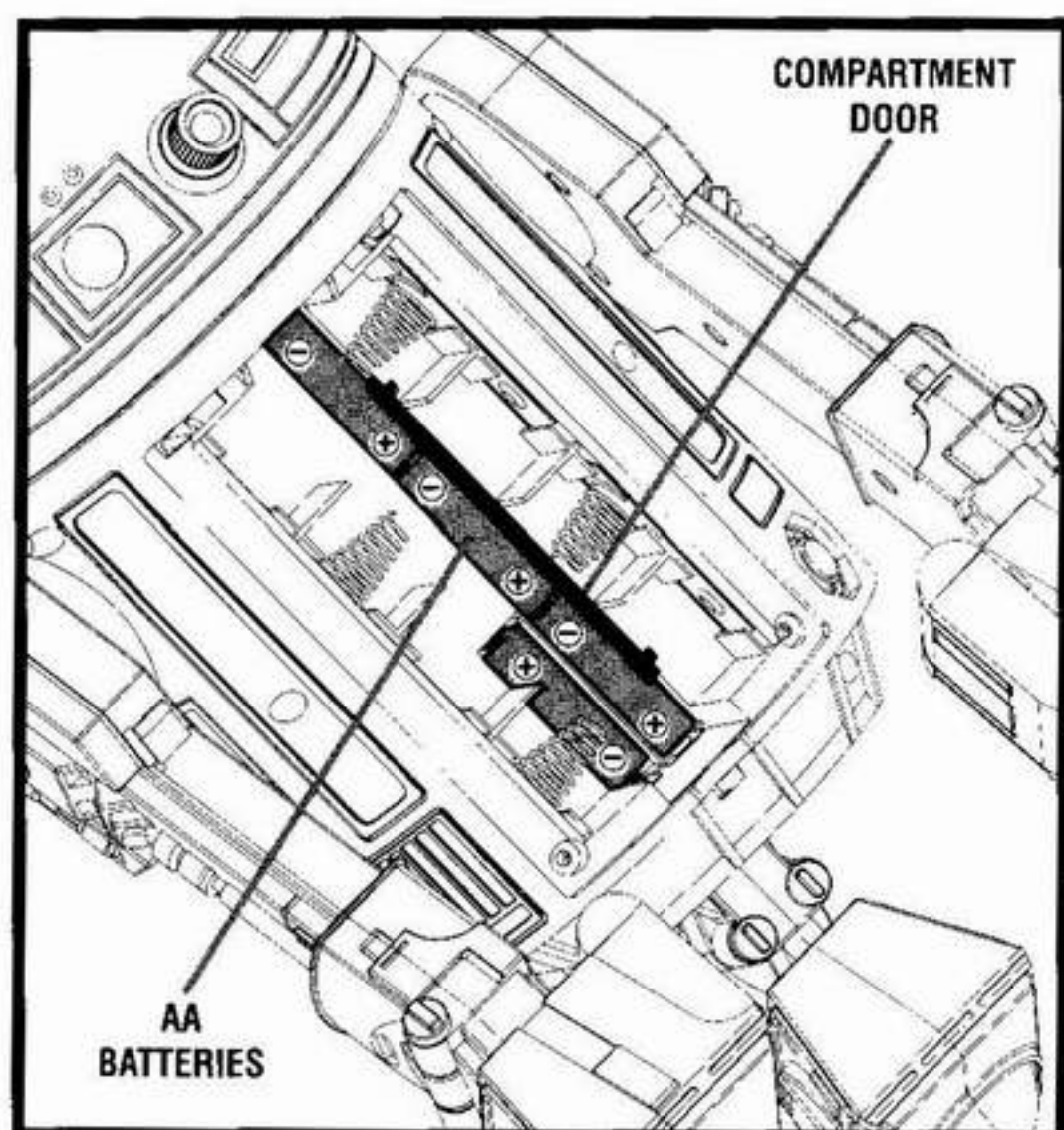
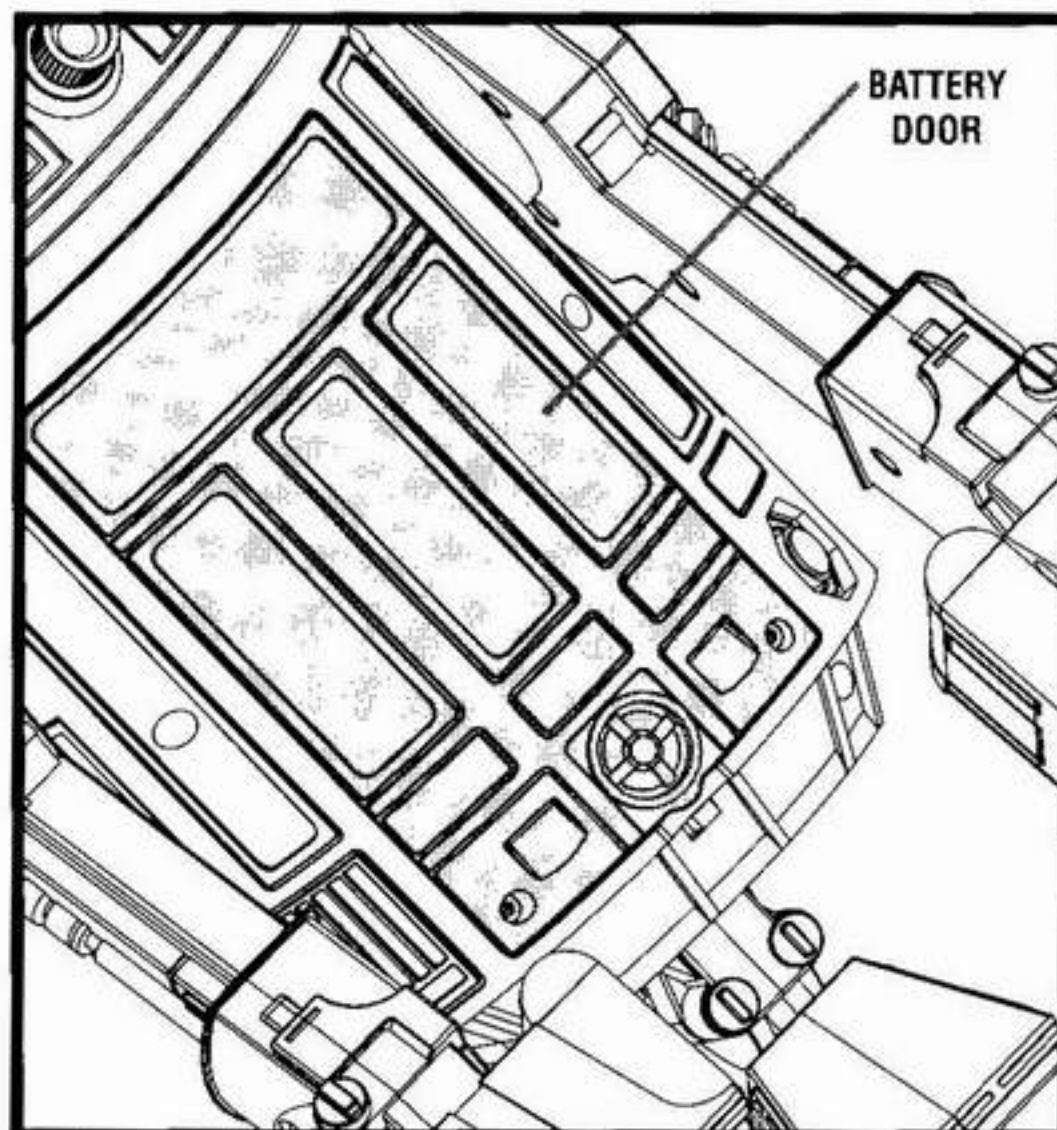

## **CAUTION:** TO AVOID BATTERY LEAKAGE

- 1) Be sure to insert the batteries correctly and always follow the toy and battery manufacturers' instructions;
- 2) Do not mix old and new batteries or alkaline, standard (carbon-zinc) or rechargeable (nickel-cadmium) batteries;
- 3) Always remove weak or dead batteries from the product.



# BEGIN OPERATION

## POWERING UP:

- 1.) Flip the switch located in the bottom back of the unit to power up your R2 unit.
- 2.) R2-D2 will automatically calibrate his head position sensor by rotating his head.
- 3.) R2-D2's lights will blink alternately between red and blue as he warms up (about thirty seconds), and then they will blink red and blue together. This indicates that the warm-up period is complete, and R2 is ready to receive commands.
- 4.) Once R2 is powered up, your droid is always on (unless you choose to turn him off manually)!

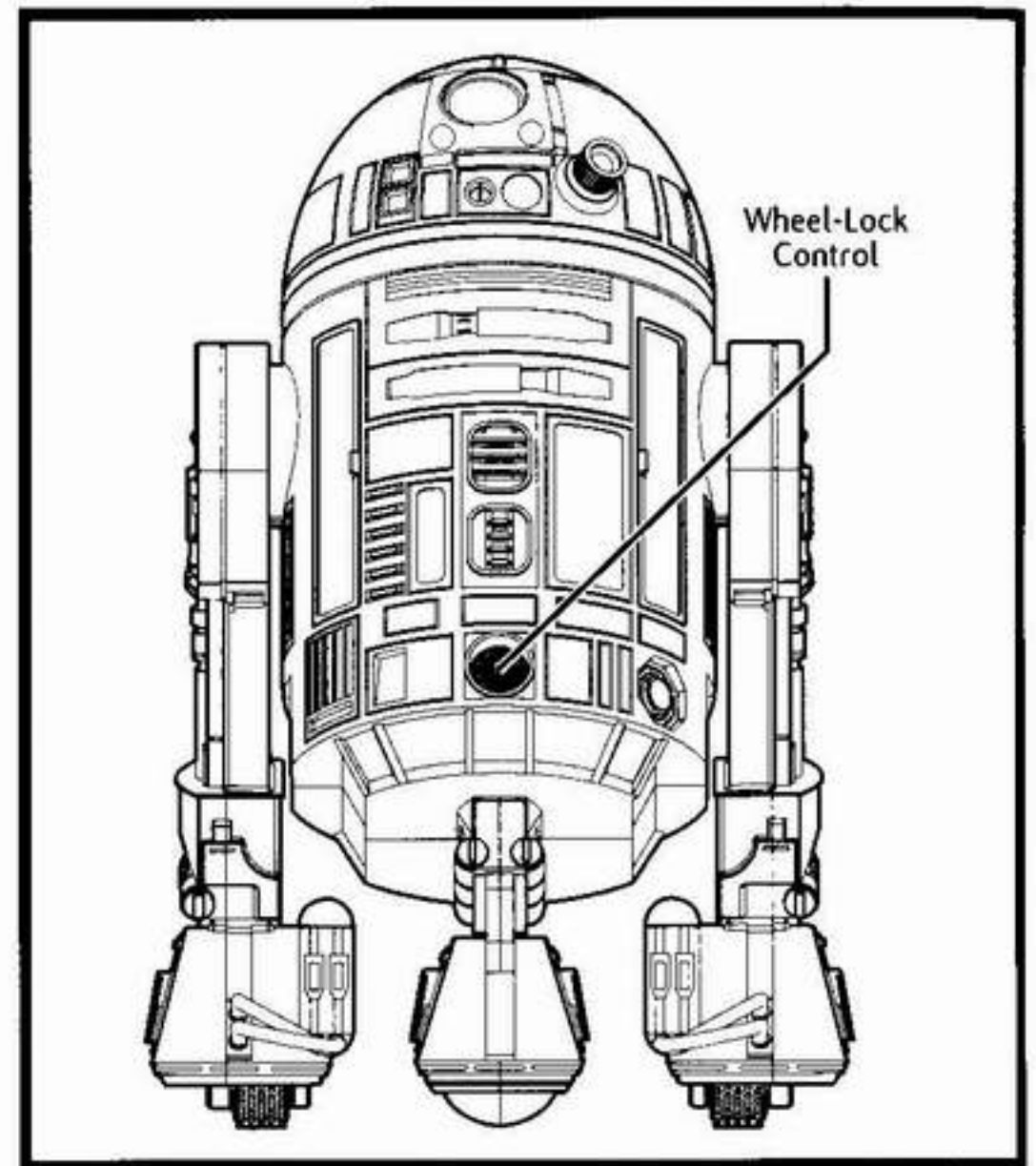
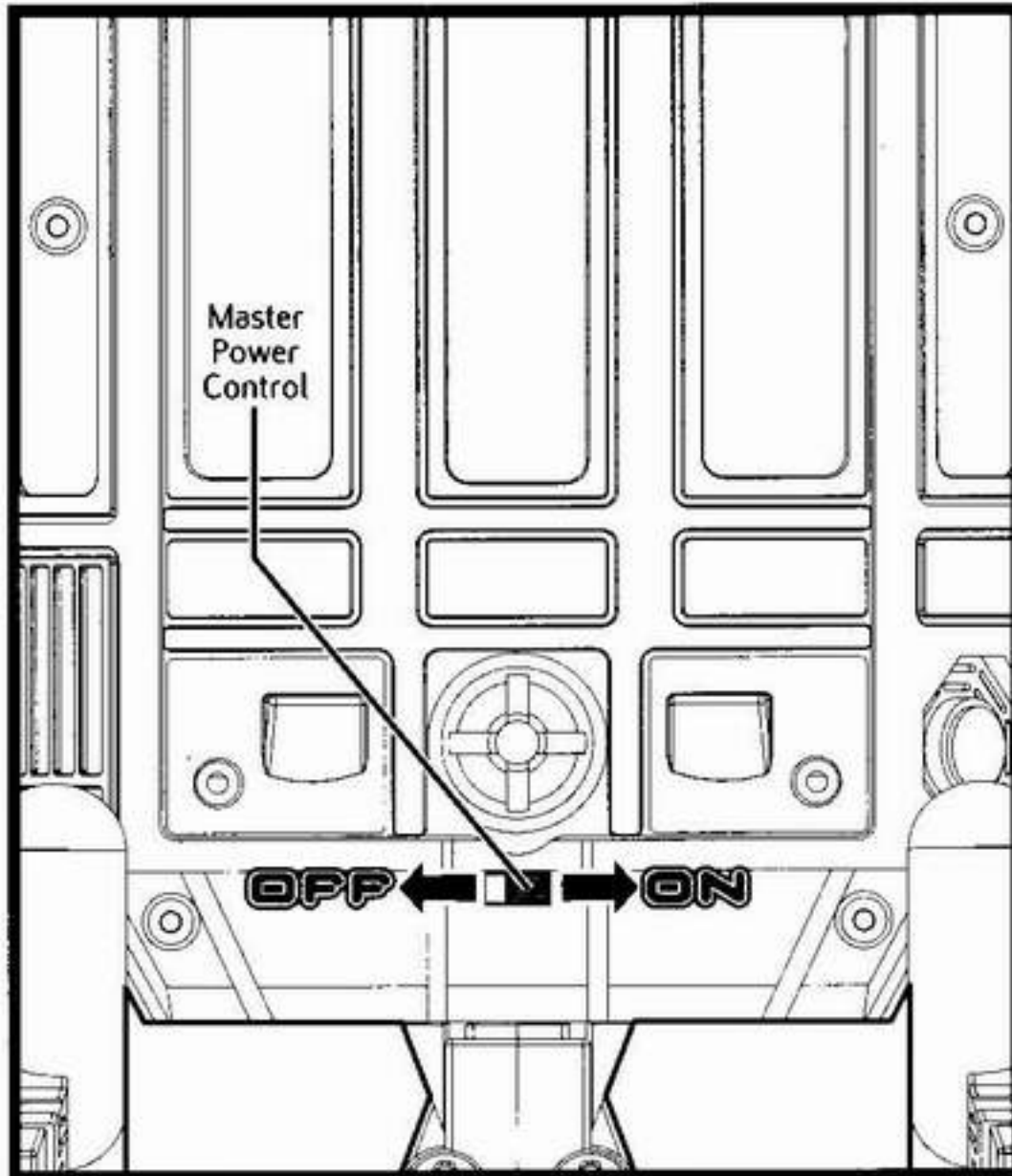

## "WHEEL-LOCK" SETTING:

When you first power up the R2 unit, the droid will remain in stationary "Wheel-Lock" mode until you press the button to release the wheels (press the same button when you want to lock the wheels again). Once the wheels are unlocked, he will move freely in response to your commands.

When you want R2 to stand in place (for instance, for tabletop use), simply press the "Wheel-Lock" button located in the front center of the unit, as shown in illustration. When in this setting, the button will light up red to indicate that the wheels are locked. Press the same button again to release the wheel-lock setting.

**Important Note:** The treads on R2-D2's steering legs can navigate floors and most carpeting. However, we strongly recommend you use R2-D2 indoors only. Never use R2-D2 near stairs, unless the stairs are protected. R2-D2 is unable to detect or navigate stairs and may fall down stairs and become damaged if not protected. Use on tabletops only in the wheel-lock setting. R2-D2 may fall from table and become damaged if wheels are not locked. You can keep R2 out of trouble by placing simple barriers in his path like sheets of cardboard. As long as it is something solid and is as tall or taller than R2, his sonar will usually detect it.

## GETTING STARTED

Now, here's where the fun really begins – your utility droid is powered up and ready for action!

### QUICK COMMANDS:

If you want to begin playing with R2-D2 right away, here are a few simple commands to get started! (This R2 unit also comes with a "Command Card" that lists in brief all of your droid's command phrases. Don't use the Command Card, however, until you've read the rest of this manual first.)

 **Say: "Hey, R2!"** to get R2-D2's attention. (Always say "Hey, R2!!" before giving him a command.)

Then try any or all of the following basic commands:

 **"Light beam!"** (The light beam on his dome flashes on! Say the same thing to turn it off!)

 **"Play message!"** (R2 will play a "secret" message.)

 **"Go on patrol!"** (R2 will patrol the room and beep when he finds someone!)

 **"Re-set system!"** (R2 will return to the beginning of his Companion Mode.)

The rest of this manual will explain in detail all of your R2 unit's modes and functions, starting with a more in-depth description of the Companion Mode.

### IMPORTANT TIPS!

- Any time, in any mode, that R2-D2's programming goes off on the wrong track and he is not responding correctly to your commands, you can say "Re-set system!" to take him back to the beginning of his Companion Mode.
- Whenever R2 is performing a command or action and you would like him to stop, simply tap him on the head (but be careful not to tap him too hard, or you might put him in a bad mood!).
- Initially, we recommend saying "Hey, R2!" before every command, to make sure that you have your droid's attention. However, as you work with your R2 unit, you will find through trial and error that this command is not always necessary. Before long, you will be familiar enough with R2-D2's habits and responses to know when you have his attention or not!
- Always wait until R2 has finished responding before giving him another command – he cannot hear you when he is talking.
- R2 will also not hear you when his motorized wheels are in motion or his head is turning; he can only hear you when he is stationary.
- For best speech recognition results, try to keep background noise as low as possible, and speak to R2 in a normal, friendly tone of voice; shouting or speaking loudly does not improve speech recognition (and it's best not to have gum or food in your mouth when you speak to him!).
- If you are talking to R2 without using any of the "command phrases" listed in this manual, he will go into conversation mode and respond to you in his trademark language of beeps and whistles. R2-D2 is a great talker and a great listener who loves to converse with you!
- R2 does not like to be picked up while he's moving. If you do so, he may stop his motors and complain!



# DETAILED DESCRIPTION & DIRECTIONS

R2-D2 has three major function modes:

- 1.) COMPANION MODE (Pages 7–8)
- 2.) GAME MODE (Page 9)
- 3.) COMMAND MODE (Pages 10 – 11)

Within each of these modes, there are many functions to explore. This manual will take you through almost all of R2-D2's actions and responses, but you'll discover more as you become more familiar with this droid; for as long as you own him, your droid will continue to surprise you with what he has to say!

Remember to save this manual for as long as you have your R2 unit! The separate "Command Card" is also invaluable as a reminder of the many commands and phrases that help you interact with R2-D2. This card can be kept in R2's storage compartment.

## COMPANION MODE DIRECTIONS

In this beginning mode, R2-D2 is his usual friendly and playful self. He loves your companionship, and loves to respond to certain commands you give him.

Stand or sit directly in front of R2 (ideally from about 2 feet, and no more than 6 feet, away), and speak clearly toward the speech sensor on the front of his body. (R2 will indicate that he is listening to you by blinking his red and blue LEDs together.)

 **Say: "Hey, R2!"**

R2-D2 will turn his head towards you and whistle to indicate he is ready for the next command!

**Remember: Always say "Hey, R2!" before giving him a command!**

Then, in no particular order, you can communicate with R2 by saying any of the following phrases:

 **Say: "Don't move!"**

And he'll remain stationary until you give him another command. (Otherwise, he may start roaming on his own!)

 **Say: "Go on patrol!"**

And he'll patrol the room for trouble. R2 will beep if he finds someone and wait for a command! If he beeps and no further commands are issued, he'll keep on patrolling. (Again, be sure to keep him away from stairs during this function!)

 **Say: "Light beam!"**

To turn his front beam on! Say it again to turn it off.

 **Say: "Play Message!"**

And he'll play a message that is stored in his memory banks from a past mission!

 **Say: "Be quiet!"**

And he'll execute his commands without beeping or whistling (except for his "yes" or "no" sounds to indicate that he has understood your commands)!

 **Say: "Speak up!"**

And he'll start talking again!



**Say: "Behave yourself!"**

When R2 gets in a bad mood, his mood status indicator light turns red and he may not respond to your commands. This command will put him back in a content mood!

**Say: "Timeout!"**

And he'll turn away, find the corner of the room and stand there like he's in trouble! (When he does this, R2 may complain just a bit, or sneak a peek over his shoulder. But when he's finished complaining, he will go to sleep.) Since R2 does not like being "punished," he usually refuses to move at first (by shaking his head). However, you can make him obey by saying "Behave yourself!" and repeating "Timeout!"

**Say: "Do you remember...?"**

And then wait for R2 to acknowledge your question with a beep. Then ask him about any of these famous friends (or enemies):

...Luke Skywalker? ...Anakin? ...C-3PO? ...Darth Vader? ...Princess Leia? ...Obi-Wan?  
...Han Solo? ...Padmé ...Chewbacca? ...Jabba the Hutt?

Every name will provoke a different response depending on how R2 feels about that particular character! Be sure to speak slowly and clearly and pause between your commands.

**Say: "Re-set system!"**

R2 will return to the beginning of his Companion Mode.

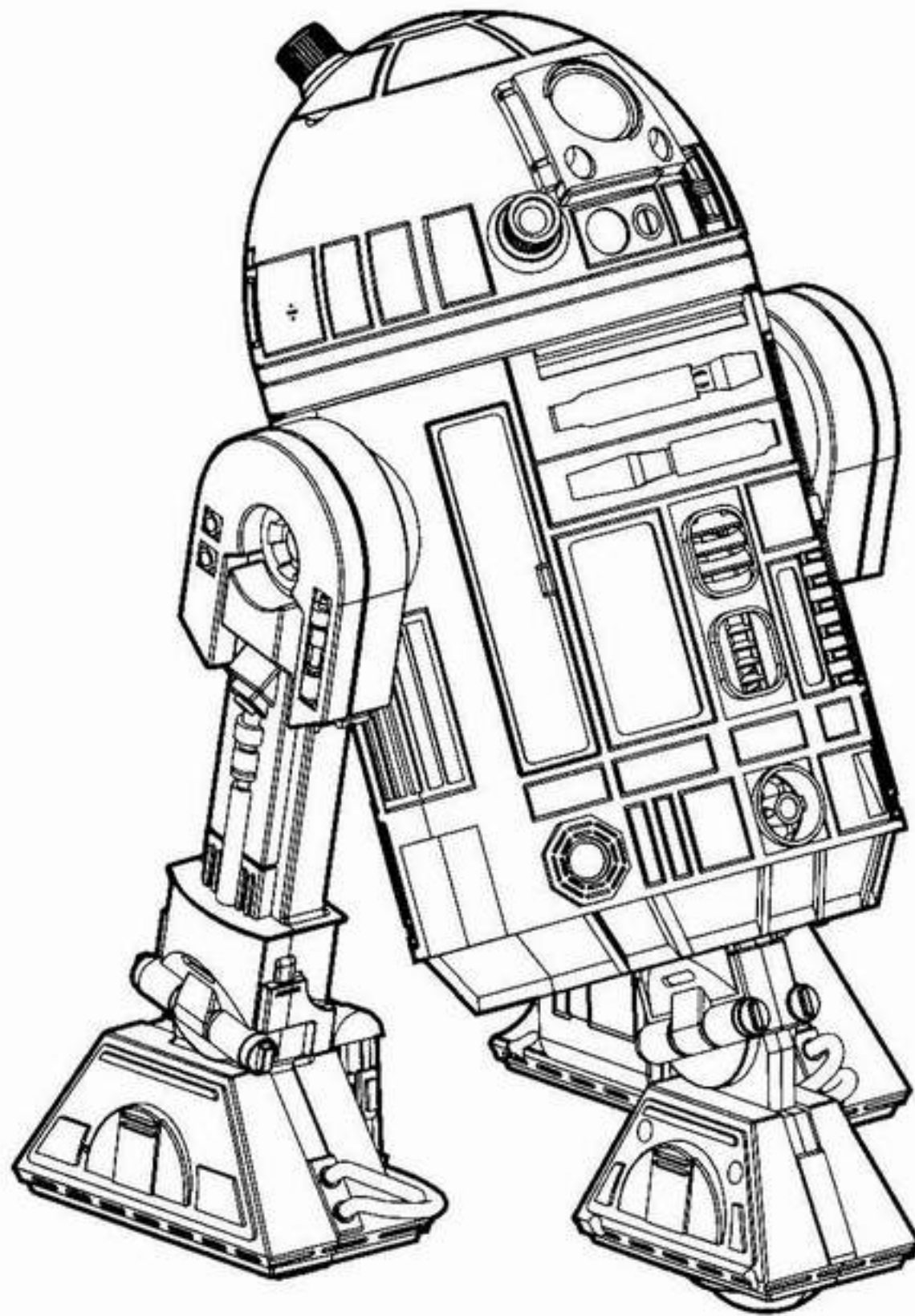

# GAME PLAY WITH R2

## GAME MODE DIRECTIONS

The Game Mode is somewhat more advanced than Companion Mode. In this mode, you and your friends can play five fun games with R2-D2:

- 1.) Light Tag
- 2.) Room Sentry
- 3.) Dance Program
- 4.) Spin the Droid
- 5.) Answer This

To start, say "Hey, R2!", wait for his response, and then say "Game Mode!" After he responds again, you may go on to any one of the following games. (Note: R2 will stay in Game Mode until you tell him to "Re-set system.")

### LIGHT TAG:

Light Tag is a hide-and-peek-style game. Say "Light Tag!" to R2-D2 and he will turn away and count to ten with a series of beeps (if he's in a mischievous mood, R2 may "cheat" by peeking over his shoulder, or start to seek before he's done counting!). When hiding, sit on the floor so that you are low enough for R2's sensors to detect you. After he's finished counting, R2 will search the room for you or your friends – when he finds somebody, he'll light up and whistle in triumph! Then say "Hey R2!" to end the game. If he cannot find any hiders for a few minutes, he gives up and emits "sad" and "frustrated" sounds. He will then revert to his default listening mode. This particular game is best played in a semi-dark room. In fact, R2's infrared sensors and sonar allow him to find you even in complete darkness!

### ROOM SENTRY:

In this game, R2-D2 can serve as sentry guard to your bedroom, or any other room. Just place R2 at the entrance of a room and say "Room Guard!" He'll do a "ten count" by flashing his light – this will allow you to leave the room without triggering an alarm. Then he will go into standby mode and start guarding the room. After that, if anybody tries to sneak past, R2's sentry light will flash. If his sound sensors or motion detector continue to sense the intruder, R2 will sound his alarm! Tap him on the head to stop the alarm; once you've shut off the alarm, he'll revert to Companion Mode and wait for a new command. If no new command is given, R2 will go back into Room sentry mode.

### DANCE PROGRAM:

Say "Dance Program!" and R2 will play cantina music and do a spinning dance! Depending on his mood, he may do a happy fast dance or a sad slow one.

### SPIN THE DROID:

This is a great party game. Gather 'round with a bunch of your friends, and say "Spin the Droid!" R2 will turn his dome around and back, around and back, scanning the crowd, before finally choosing one person by locking onto that person, flashing his light beam and playing a song! Recommended for up to 6 players. For best results, there should be a clear gap between each player.

### ANSWER THIS:

Say "Answer This!", then ask R2-D2 a Yes or No question. He'll answer the question with a happy-sounding "Yes!" or shake his head and beep a negative-sounding "No!" R2-D2 may answer differently depending on his mood. To stop this game, tap R2 gently on the head and tell him to "Re-set system."



# NAVIGATING R2

## COMMAND MODE DIRECTIONS

The Command Mode is the most advanced of the three modes. It involves directing R2's movements and navigating him through courses and obstacles. The voice commands in this mode are more complex, and without clear direction R2-D2 can easily become confused. You should go into this mode only after you've familiarized yourself with the Companion and Game Modes.

### Real-Time Maneuvering:

In Command Mode you give R2-D2 a series of commands then ask him to execute the series. Say "Hey, R2!" to start, then say "Command Mode!" Continue by giving him any one of the directions below. Finally, qualify your command by specifying a distance from one to five units:

- "Turn around!" (No distance command required)
- "Go forward!" (Then: "One unit", "two units"... up to five)
- "Turn right!" (Then: "One unit", "two units"... up to five)
- "Turn left!" (Then: "One unit", "two units"... up to five)

**Important Note:** After each command, be sure to wait for R2's acknowledging beep before giving him the next command. For example: say "Hey R2" {"beep"}, say "Command mode!" {"beep"}, say "Go forward" {"beep"}, say "Three units!" {"beep"}.

R2 will carry out your command by moving in the direction and the distance you told him to! In this way, you can keep giving R2 individual commands to help him navigate tricky corners and obstacle-laden courses. (The length of each unit varies on different floors. Try different commands until you get a sense of how R2 moves on a particular floor covering.) If R2 is prevented from completing this command by an obstacle, he will abort the command and complain!

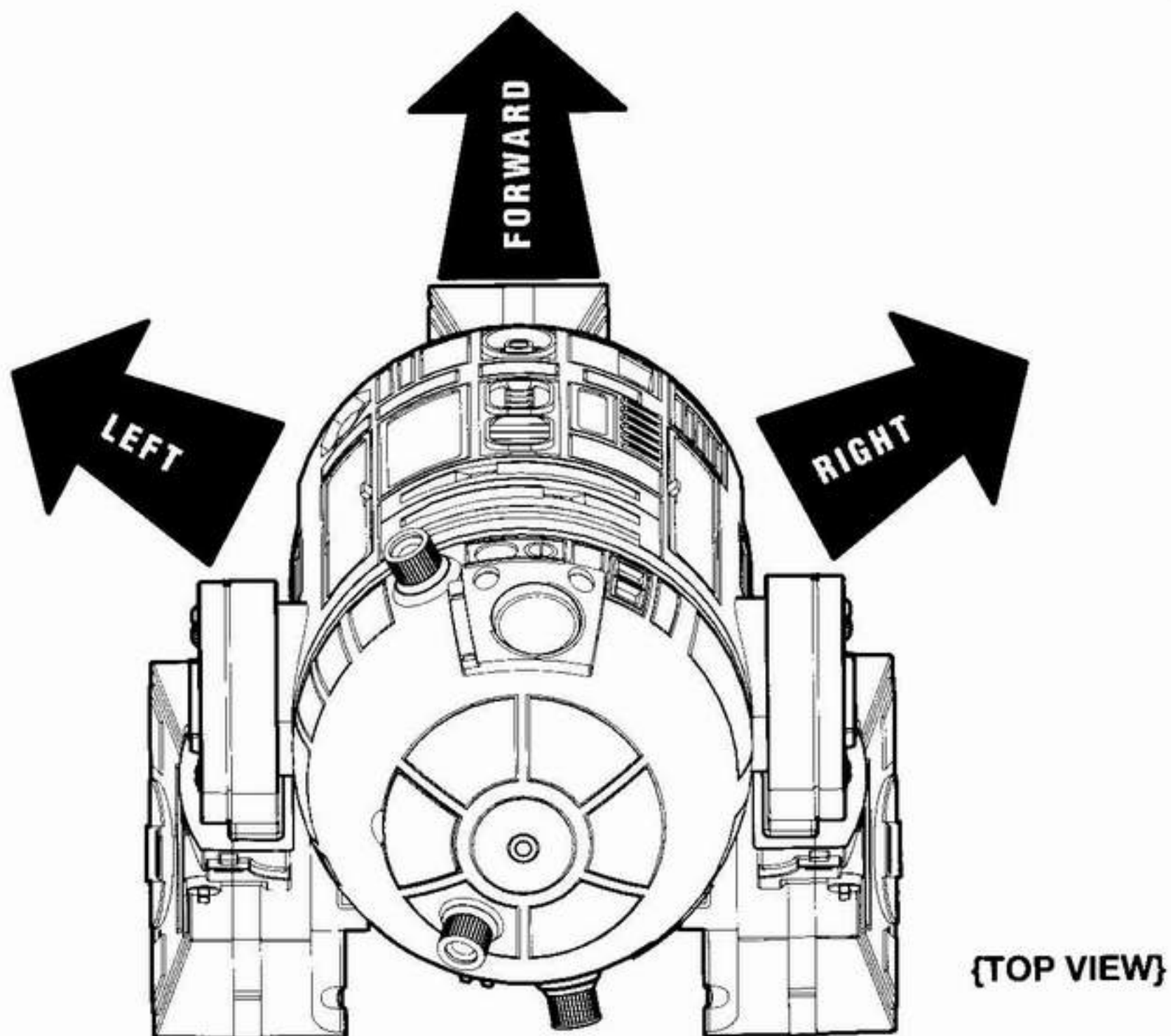

## Programming Courses:

You can also program and store a series of commands and ask R2 to execute the series all at once. To do this, say "Hey, R2!", then "Command Mode!", then "Plot course!" Give R2 several commands as described above, i.e. each command consisting of a direction and a distance. Once you've completed a series, say "Execute course!" and R2-D2 will do just that! Remember to wait for R2's acknowledging beep after each command before giving him another command.

If you reach the maximum number of commands that R2's memory banks can hold (about twenty), R2 will launch into the series immediately. Any time you want to erase a command series, simply say "Plot course" then say "Delete course!" R2 will remain in Command Mode, but will delete the stored series. (It is not possible to delete just one command in a series, only the entire course.) Also, if you turn R2 off manually, he will wipe the course from his memory.

Remember, at any time, you can say "Re-set system!" to bring R2 back to his Companion Mode. This will not delete the stored course.

The many levels of R2-D2's programming will ensure lots of fun and discovery with this loyal, lovable, multi-talented droid. Have fun!

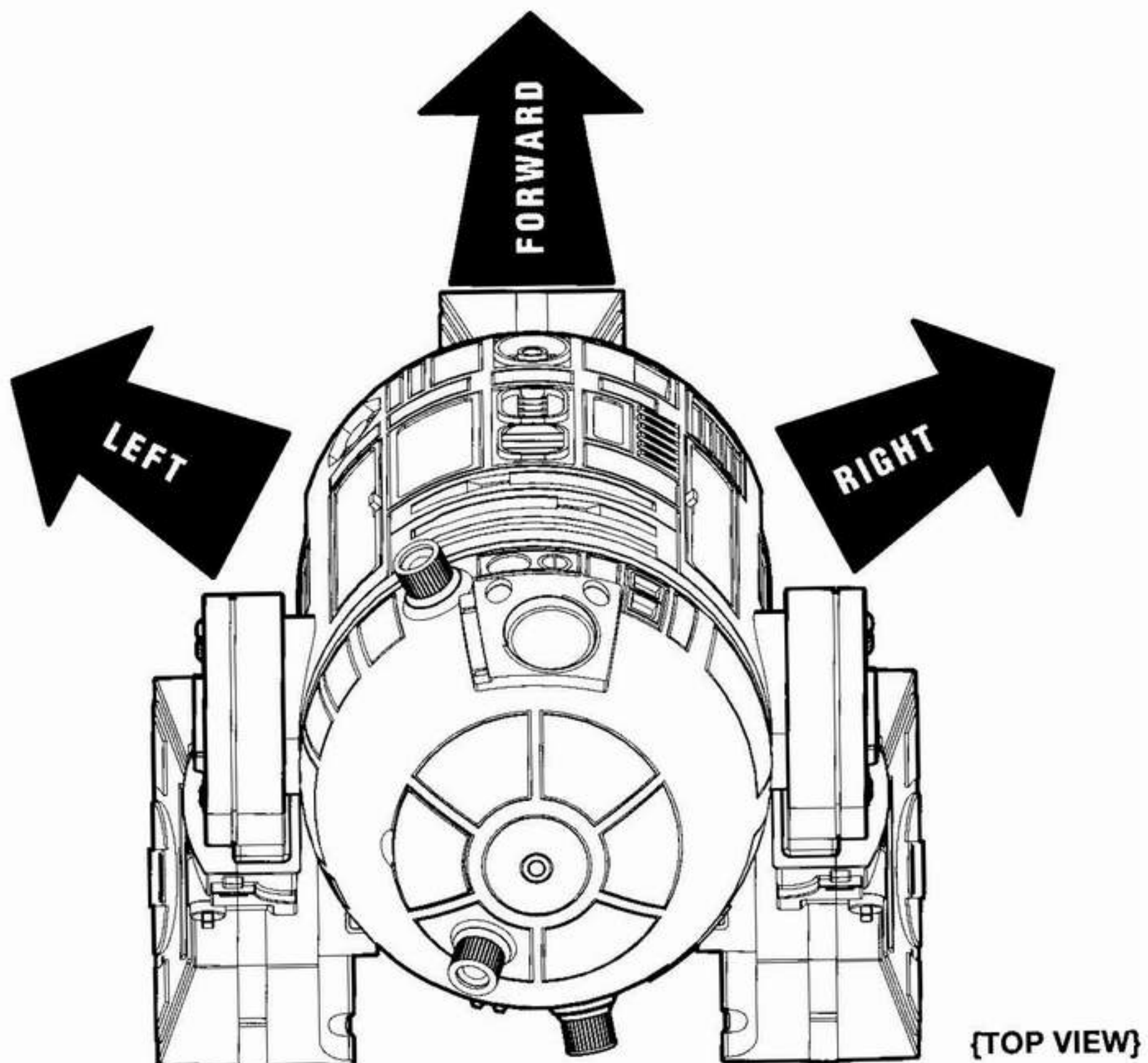



## R2 ON HIS OWN

### "STANDBY" SETTING:

- 1.) R2 will automatically revert to his battery-conserving "Standby" setting if he is unable to find someone to interact with for several minutes (for example, if he can't find anyone during Light Tag, or when he's on patrol). When reverting to this mode, his red LED will flash on and off, then turn off completely. While in Standby, R2 will "wake up" when you talk directly to him, when he senses motion in front of him, or when you tap him gently on the head.
- 2.) You may also put R2 into "Standby" setting directly by saying "Switch off!" when he is in Command Mode.
- 3.) If you will not be playing with R2-D2 for extended periods of time (more than two or three days), it is recommended that you manually turn his Master Power Control to the "OFF" position.

### TROUBLESHOOTING:

- If R2-D2 starts responding sluggishly, it is likely that his batteries need to be replaced. In general, if his motion is sluggish even on flat surfaces or his lights seem dim, the "D" batteries need to be replaced; most other types of trouble (sounds, recognition) indicate that the "AA" batteries need replacement. If R2 shuts off during play, or right after you turn him on, replace the "AA" batteries.
- Bright light, or temperatures above 77 F or below 65 F, may disorient R2; under these conditions, he may have trouble seeing and finding people as usual.
- If you place an object in R2-D2's utility arm that is too large or too heavy, he will not be able to move properly; simply remove the item, and he will return to normal function.
- If any of R2's parts (for instance, his steering legs) come off during play or when he is dropped, simply follow the assembly instructions in this manual to re-assemble the part(s).
- If you need help, please call 1-800-327-8264, or visit [www.starwars.hasbro.com](http://www.starwars.hasbro.com)

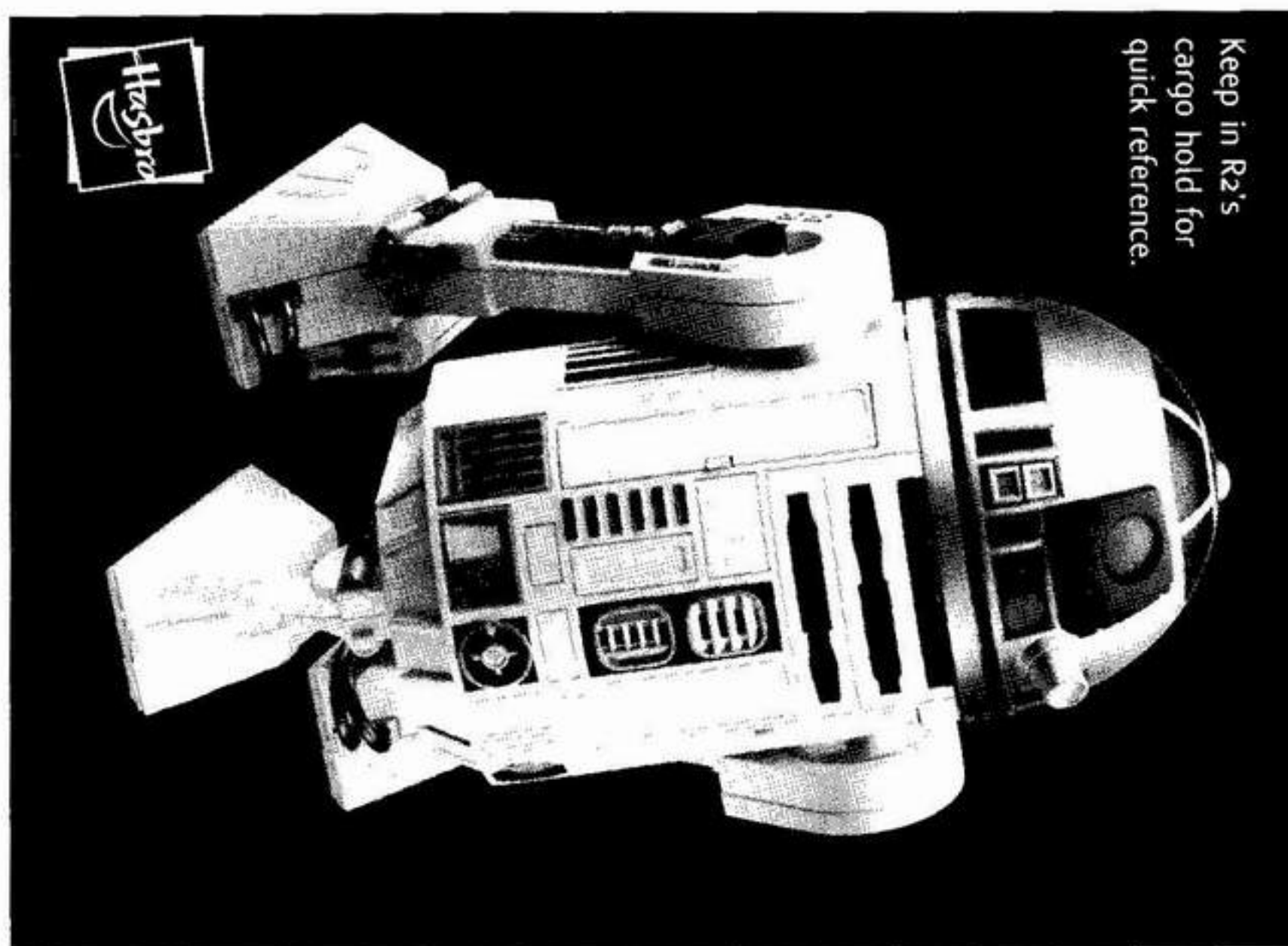

Keep in R2's  
cargo hold for  
quick reference.

**INDUSTRIAL ROTOMATION**  
**R2-D2**  
Command Card

# USING R2-D2'S INTERGALACTIC BEVERAGE HOLDER/UTILITY ARM

- 1.) Open door.
- 2.) Swing down utility arm.
- 3.) Open clamp and place beverage container (not included) in clamp.

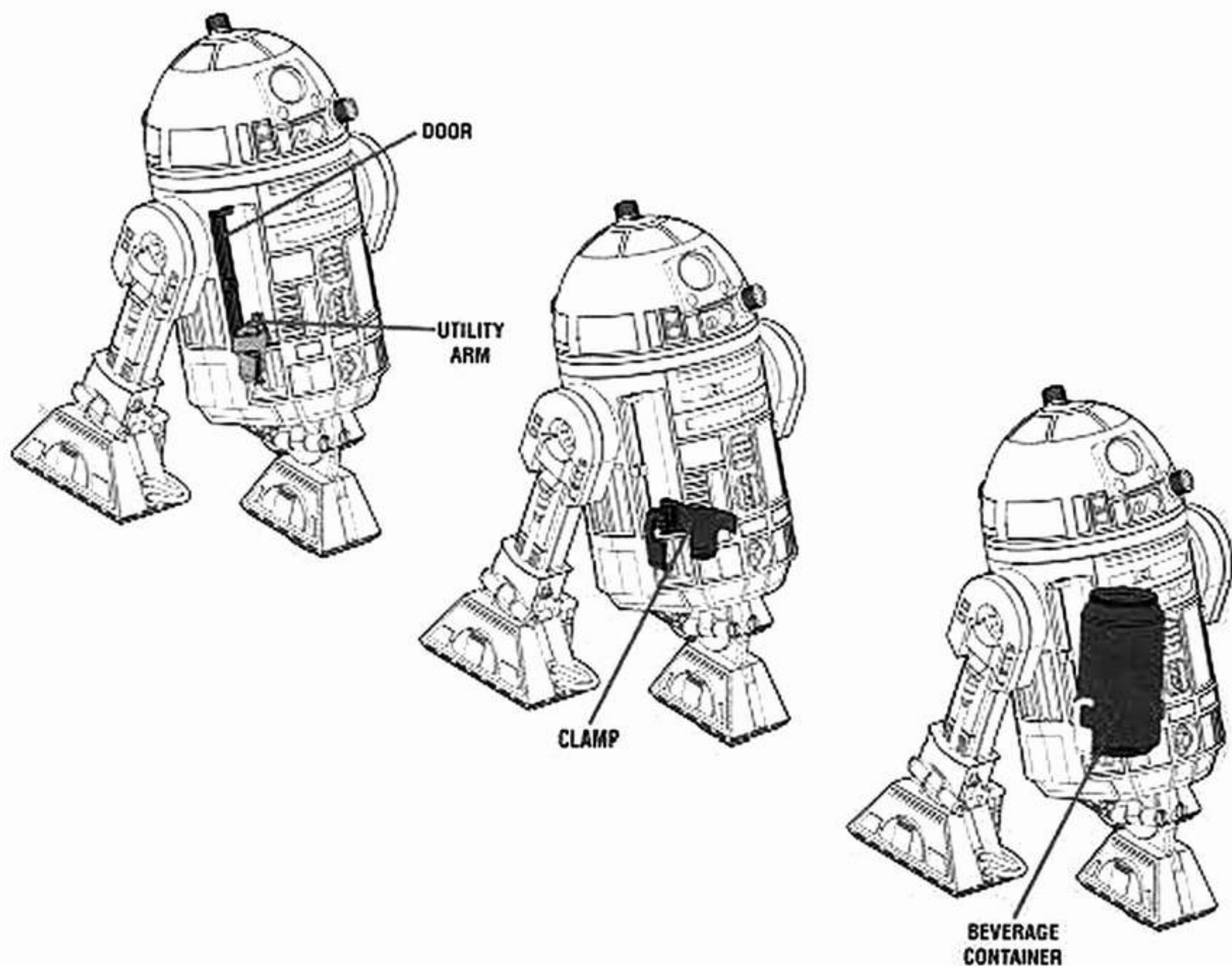

Cut along dotted line. Keep this card in R2's cargo hold for quick reference.

Say: "Hey, R2!"

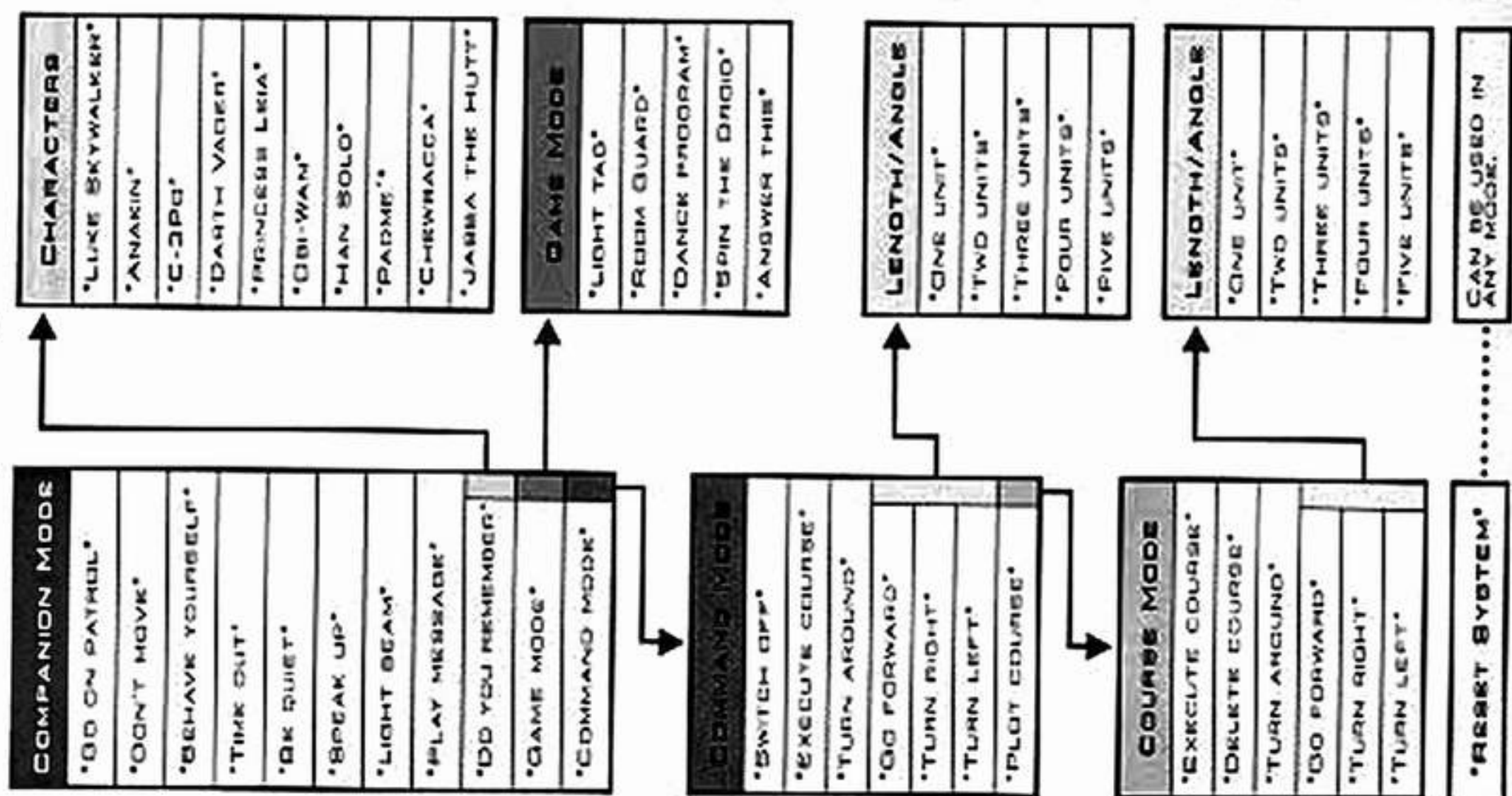



## TECH SPECS

Industrial Automaton has adjusted your R2 unit with many new features and functions for use on Earth.

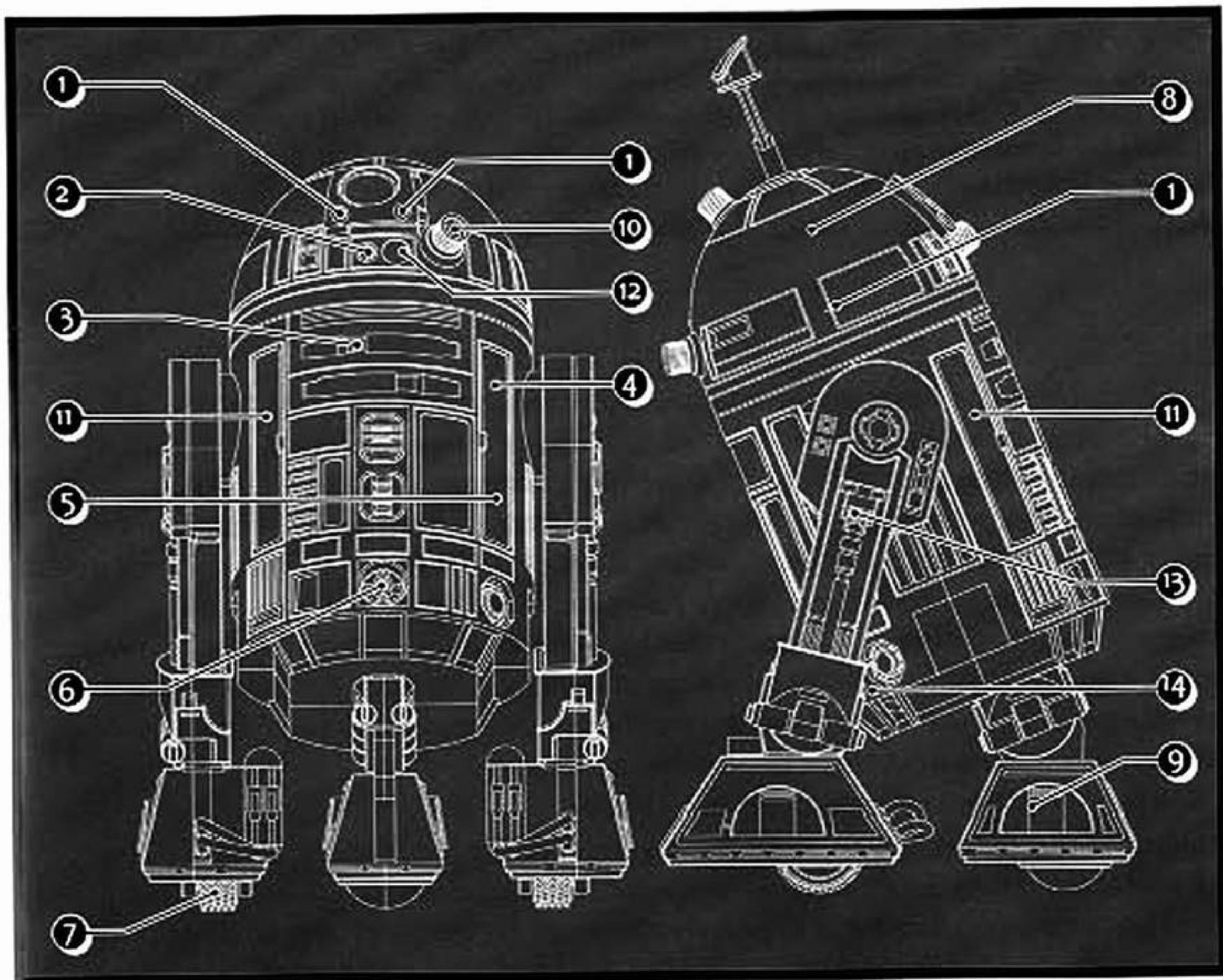

1. NAVIGATION SENSORS (WITH SOUND PROCESSING MICROPHONES AND SONAR; THESE HELP R2 "SEE" AND LOCATE OBJECTS)
2. INFRARED LOCATION SENSORS (FOR DETECTING LIFEFORMS)
3. VOICE RECOGNITION RESPONSE MODULE (HOW R2 "HEARS": TALK INTO HERE!)
4. CARGO HOLD
5. STORAGE AREA (KEEP YOUR "COMMAND CARD" IN HERE!)
6. WHEEL LOCK CONTROL (FOR WHEN YOU WANT R2 TO REMAIN STATIONARY)
7. MOTORIZED, INDOOR-TERRAIN TREADS (HELP R2 NAVIGATE WOOD FLOORS, TILE FLOORS AND MOST CARPETING!)
8. SLEEK ROTATING DOME (CAN TURN ALMOST 360 DEGREES!)
9. CENTER LEG
10. ILLUMINATING LIGHT BEAM
11. INTERGALACTIC BEVERAGE HOLDER/UTILITY ARM (DESIGNED TO HOLD A 12-OUNCE BEVERAGE CAN)
12. ADAPTABLE DROID MOOD STATUS INDICATOR (RED AND BLUE LEDES INDICATE R2'S MOOD)
13. STEERING LEGS
14. MASTER POWER CONTROL (MANUAL ON/OFF SWITCH; R2 ALSO FEATURES AUTOMATIC "STANDBY" MODE TO CONSERVE BATTERY LIFE)



**Important Note:** The treads on R2-D2's steering legs can navigate floors and most carpeting. However, we strongly recommend you use R2-D2 indoors only. Never use R2-D2 near stairs, unless the stairs are protected. R2-D2 is unable to detect or navigate stairs and may fall down stairs and become damaged if not protected. Use on tabletops only in the wheel-lock setting. R2-D2 may fall from table and become damaged if wheels are not locked. You can keep R2 out of trouble by placing simple barriers in his path like sheets of cardboard. As long as it is something solid and is as tall or taller than R2, his sonar will usually detect it.

#### FCC STATEMENT:

This equipment has been tested and found to comply with the limits for a Class B digital device, pursuant to part 15 of the FCC Rules. These limits are designed to provide reasonable protection against harmful interference in a residential installation. This equipment generates, uses and can radiate radio frequency energy, and, if not installed and used in accordance with the instructions, may cause harmful interference to radio communications. However, there is no guarantee that interference will not occur in a particular installation. If this equipment does cause harmful interference to radio or television reception, which can be determined by turning the equipment off and on, the user is encouraged to try to correct the interference by one or more of the following measures:

- Reorient or relocate the receiving antenna.
- Increase the separation between the equipment and the receiver.
- Consult the dealer or an experienced radio/TV technician for help.

Changes or modifications not expressly approved by the party responsible for compliance could void the user's authority to operate the equipment.



Product and colors may vary.

© 2002 Lucasfilm Ltd. & © or TM where indicated. All rights reserved. Used under authorization.

® and/or TM & © 2002 Hasbro. All Rights Reserved.

© denotes Reg. U.S. Pat. & TM Office.

CyberLife technology used in this product © 2001 Creature Labs Ltd. Patents Applied for. The egg logo is a trademark of Creature Labs Ltd. All rights reserved.

Voice Signal and the Voice Signal logo are trademarks of Voice Signal Technologies, Inc.



Creature Labs™

POWERED BY



VoiceSignal

P/N 6162290010