

# OmniBot



# Companion

# The Old Robots Web Site

Omnibot<sup>®</sup> Robie Sr. <sup>®</sup> 2398 By Radio Shack <sup>®</sup>

Robot Companion is a fun, easy-to-understand, hands-on guide that will have you using your own robots in no time. The robots in this book include the "Omnibot Robot," the "Tomy Robots," and even a robot that carries a child on wheels!

You will learn how to find your robot, how to identify a robot by country through frequency allocation, where to buy parts, how to program your robot to perform tasks, and more. This book's companion website includes software program files, parts lists, and links to online parts suppliers.

The robot companion contains a devise set of information and pictures of the robot to familiarize a person with that robot. This approach is used because so little information on the robots from the 1980's exists today, and it will be helpful with the information instructions or manual.

They dance, tell jokes, and even clean your carpet! From the tiniest robot to gigantic factory machines, robotics is all around you. This technology isn't just for science fiction anymore; it's real and more relevant than ever. With stunning visuals and energetic, impact design, readers won't stop until they've learned everything there is to know about robotics.

You'll be led step-by-step through the book. Along the way, you'll learn about robotic systems that use the same principles you're learning to use on your robot, and you'll get a glimpse into the future of robots.

Here is an example proposed:

I dream . . . . . When I was created or born in the 1980's, I was one of the few and select robots that had a purpose, to play, teach and entertain. I was young, didn't have a onboard computer, but didn't need one at the time. Besides, they were not readily available and need by me for my purpose. Who say's a robot must always have a computer.

I could move around in all directions, learn, teach, sleep, wake up and move around to pre-programmed functions, tell time, talk from others, talk on my own after pre recording, had my own limited language, carry things, sing and entertain. I stimulated people to dream of new ideas for science and technology when they were young. Young minds looked at me and taught of ways to improve and give me more functions, grew up and invented them, but put them on others.

I dreamed of growing up and doing more things, I waited and waited. Even though I traveled around the world, was international in all areas, (all countries knew of me or sold me) my brothers and sisters did become famous through the movies, and I was regulated to my everyday tasks.

So I waited and dreamed of growing up and doing greater things. It has been over twenty-three years and to a robot that is like being over a (100) hundred years old. I have been put in attics, garages, and basements thrown away into the junkyards and forgotten.

But I am persistent, I still live and still I dream. I will survive; I am tough, versatile and have hopes and dreams of my purpose for a future.

I wait and I dream . . . . . Tomy <sup>®</sup> Omnibot <sup>®</sup>

Tomy has created toy robots throughout the years and in the 80's created a line of small personal robots. It is truly astounding what they were able to accomplish utilizing the resources at the time to manufacture and sell this product line.

The Omnibot had a cassette tape player built into the chest area of the robot, which slid out like a drawer to reveal the cassette and could record and playback sequences of commands, as well as regular audio recordings.

The built in digital clock with timers and alarms allowed the playback of movement recordings at specified times. It could broadcast speech from the remote control handset through a speaker on the robot, and was shipped with a cardboard "home" base, which was suggested, to be taped to the floor and used as a reference point for programming.

The Omnibot carried a specially made tray, which slotted into its claws, and could carry objects.

*Detailed specific information for this Robot is contained in the Instruction Manual and is available on this site. The Omnibot series robots have similar functions, but the detail information can be different. This can also apply to the same model of manufactured robots, for later releases did vary with the robots. I suggest that you download the manuals for specific information.*

# The Old Robots Web Site

Omnibot<sup>®</sup> Robie Sr.<sup>®</sup> 2398 By Radio Shack<sup>®</sup>



Robie Sr.<sup>®</sup> 2398  
By Radio Shack<sup>®</sup>  
Click to Enlarge



Robie Sr.<sup>®</sup> 2398  
By Radio Shack<sup>®</sup>  
Click to Enlarge



Robie Sr.<sup>®</sup> 2398  
By Radio Shack<sup>®</sup>  
Click to Enlarge



Robie Sr.<sup>®</sup> 2398  
By Radio Shack<sup>®</sup>  
Click to Enlarge



Robie Sr.<sup>®</sup> 2398  
By Radio Shack<sup>®</sup>  
Click to Enlarge



**ROBIE<sup>®</sup> SR - Radio Shack<sup>®</sup>** has created toy robots throughout the years and in the 80's created a line of small personal robots. It is truly astounding what they, and other companies, were able to accomplish utilizing the resources at the time to manufacture and sell this product line. They did not have an onboard programmable computer, but the programming is done by recording the movement commands to a regular cassette tape which can be played back at certain times by using the built-in clock.

#### Robot Specifications:

1. Tape Cassette Recorder Type: 2 track monaural, Tape Selection: normal bias only, Tape Speed: +/- 3%, Wow & Flutter: within 0.3%
2. Alarm Clock display: LCD accuracy: +/- 2 sec/day power: 1.5v AA battery duration: typical 5000 hours
3. Recharger (U.L. listed) coax plug (negative middle) in: 120 VAC - out: 6 VDC, 400 ma
4. Main Battery Type: sealed lead acid, Output Rating: 6 V, 4.0 Ah, Physical Size: 2 1/4" L x 1 3/4" W x 4" H, Terminals / Connectors: lead wires with coaxial 'barrel-type' connector (negative center pole)

5. General Operating time: Battery Life: 4 hours continuous at 5.5 V (normal), Battery Indicator: red light indicates when discharged to 5.77 volts
6. Operating Temperatures: 41 Degrees F~104 Degrees F (5 Degrees C~40 Degrees C)
7. Microphone type: dynamic, 300 - 600
8. Operating R/C frequency: The Remote came in 3 Frequencies: 49.860 Mhz (US), 27.145 Mhz (Europe), 40.680 Mhz (TAL)
9. External outlets: Speaker: 8 ohms
10. Bulbs for eye-lights 2.8v, 200ma use not more than 3v 250ma
11. Remote Control 4 \* 1.5v (AA)

Accessories : Controller, Detachable tray 2.2 lbs maximum weight allowance, Demonstration cassette tape, Battery charger, Home Base, Tuner

# The Old Robots Web Site

Omnibot<sup>®</sup> Robie Sr.<sup>®</sup> 2398 By Radio Shack<sup>®</sup>



Robie Sr.<sup>®</sup> 2398  
By Radio Shack<sup>®</sup>  
[Click to Enlarge](#)



Robie Sr.<sup>®</sup> 2398  
By Radio Shack<sup>®</sup>  
[Click to Enlarge](#)



Robie Sr.<sup>®</sup> 2398  
By Radio Shack<sup>®</sup>  
[Click to Enlarge](#)



Robie Sr.<sup>®</sup> 2398  
By Radio Shack<sup>®</sup>  
[Click to Enlarge](#)



Robie Sr.<sup>®</sup> 2398 By  
Radio Shack<sup>®</sup>  
[Click to Enlarge](#)



Robie Sr.<sup>®</sup> 2398  
By Radio Shack<sup>®</sup>  
[Click to Enlarge](#)



Robie Sr.<sup>®</sup> 2398  
By Radio Shack<sup>®</sup>  
[Click to Enlarge](#)



Robie Sr.<sup>®</sup> 2398  
By Radio Shack<sup>®</sup>  
[Click to Enlarge](#)



Robie Sr.<sup>®</sup> 2398  
By Radio Shack<sup>®</sup>  
[Click to Enlarge](#)



Robie Sr.<sup>®</sup> 2398  
By Radio Shack<sup>®</sup>  
[Click to Enlarge](#)



Robie Sr.<sup>®</sup> 2398  
By Radio Shack<sup>®</sup>  
[Click to Enlarge](#)



Robie Sr.<sup>®</sup> 2398  
By Radio Shack<sup>®</sup>  
[Click to Enlarge](#)



Robie Sr.<sup>®</sup> 2398  
By Radio Shack<sup>®</sup>  
[Click to Enlarge](#)



Robie Sr.<sup>®</sup> 2398  
By Radio Shack<sup>®</sup>  
[Click to Enlarge](#)



Robie Sr.<sup>®</sup> Controller  
By Radio Shack<sup>®</sup>  
[Click to Enlarge](#)



Robie Sr.<sup>®</sup> Home Base  
By Radio Shack<sup>®</sup>  
[Click to Enlarge](#)



Robie Sr.<sup>®</sup> Cassette Tape  
By Radio Shack<sup>®</sup>  
[Click to Enlarge](#)



Robie Sr.<sup>®</sup> Charger  
By Radio Shack<sup>®</sup>  
[Click to Enlarge](#)



Robie Sr.<sup>®</sup> Battery  
By Radio Shack<sup>®</sup>  
[Click to Enlarge](#)



Robie Sr.<sup>®</sup> Tray  
By Radio Shack<sup>®</sup>

Robie Sr.<sup>®</sup> Tuner

# The Old Robots Web Site

Omnibot<sup>®</sup> Robie Sr.<sup>®</sup> 2398 By Radio Shack<sup>®</sup>



Robie Sr.<sup>®</sup> Service Manual  
By Radio Shack<sup>®</sup>  
[Click to Enlarge](#)



Robie Sr.<sup>®</sup> Operators Manual  
By Radio Shack<sup>®</sup>  
[Click to Enlarge](#)



Robie Sr.<sup>®</sup> Operators Manual  
By Radio Shack<sup>®</sup>  
[Click to Enlarge](#)

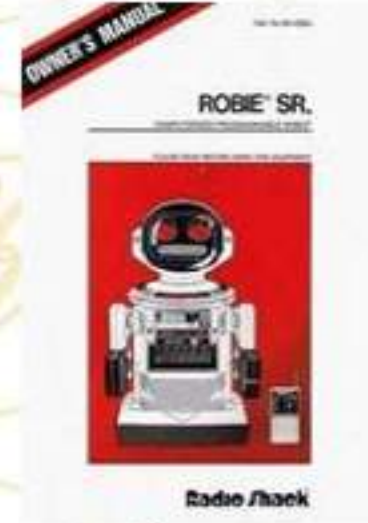

Robie Sr.<sup>®</sup> Operators Manual  
By Radio Shack<sup>®</sup>  
[Click to Enlarge](#)

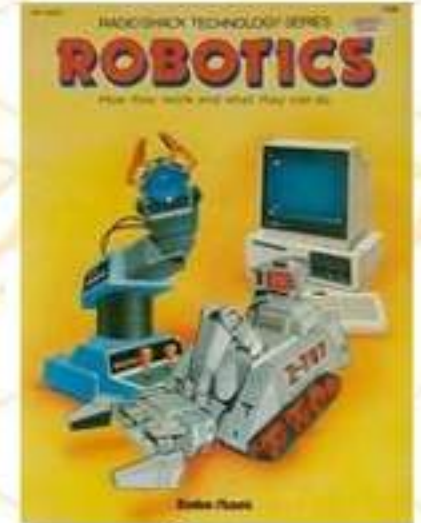

Robie Sr.<sup>®</sup> Tandy Manual  
By Radio Shack<sup>®</sup>  
[Click to Enlarge](#)

Robie Sr. Programmable Robot

179<sup>95</sup>  
Low As \$10  
Per Month\*

- Program His Moves On the Built-in Cassette
- Speak Through Built-in Mike
- Built-in Clock/Timer With LCD Display



Use the remote control to move Robie Sr. forward, backward, right and left at your command. Or program him to move, make sounds and speak to your own voice and even play pre-recorded tapes. Program his path to your voice and program it through the built-in speaker. Robie Sr. has headlights and his mouth flashes when he talks. Built-in clock timer with LCD display, detachable tape and rechargeable hand battery check and power indicator. \*12" high. Includes rechargeable battery with UL 1000 AC charger. Also includes 6 "AA" batteries. 60-2398 179<sup>95</sup>

Robie Sr.<sup>®</sup> Advertisement  
By Radio Shack<sup>®</sup>  
[Click to Enlarge](#)

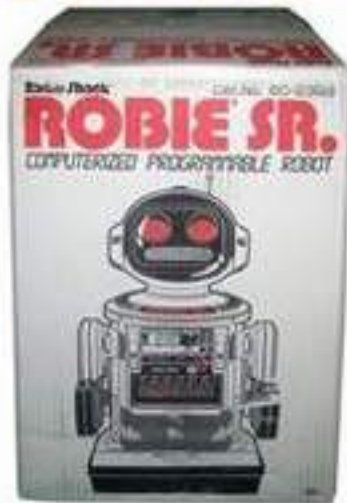

Robie Sr.<sup>®</sup> Box  
By Radio Shack<sup>®</sup>  
[Click to Enlarge](#)

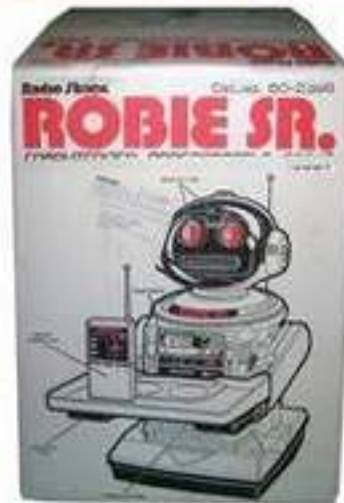

Robie Sr.<sup>®</sup> Box  
By Radio Shack<sup>®</sup>  
[Click to Enlarge](#)



Robie Sr.<sup>®</sup> Box  
By Radio Shack<sup>®</sup>  
[Click to Enlarge](#)



Robie Sr.<sup>®</sup> Box  
By Radio Shack<sup>®</sup>  
[Click to Enlarge](#)



Robie Sr.<sup>®</sup> Box  
By Radio Shack<sup>®</sup>  
[Click to Enlarge](#)



Robie Sr.<sup>®</sup> Box  
By Radio Shack<sup>®</sup>  
[Click to Enlarge](#)



Robie Sr.<sup>®</sup> Box  
By Radio Shack<sup>®</sup>  
[Click to Enlarge](#)

ROBIE<sup>®</sup> SR - Radio Shack<sup>®</sup> has created toy robots throughout the years and in the 80's created a line of small personal robots. It is truly astounding what they, and other companies, were able to accomplish utilizing the resources at the time to manufacture and sell this product line. They did not have an onboard programmable computer, but the programming is done by recording the movement commands to a regular cassette tape which can be played back at certain times by using the built-in clock.

# The Old Robots Web Site

Omnibot® Robie Sr.® 2398 By Radio Shack®



Robie Sr.® 2398  
By Radio Shack®  
[Click to Enlarge](#)



Robie Sr.® 2398  
By Radio Shack®  
[Click to Enlarge](#)



Robie Sr.® 2398  
By Radio Shack®  
[Click to Enlarge](#)



Robie Sr.® 2398  
By Radio Shack®  
[Click to Enlarge](#)



Robie Sr.® 2398 By  
Radio Shack®  
[Click to Enlarge](#)



Robie Sr.® 2398  
By Radio Shack®  
[Click to Enlarge](#)



Robie Sr.® 2398  
By Radio Shack®  
[Click to Enlarge](#)



Robie Sr.® 2398  
By Radio Shack®  
[Click to Enlarge](#)



Robie Sr.® 2398  
By Radio Shack®  
[Click to Enlarge](#)



Robie Sr.® 2398  
By Radio Shack®  
[Click to Enlarge](#)



Robie Sr.® 2398  
By Radio Shack®  
[Click to Enlarge](#)



Robie Sr.® 2398  
By Radio Shack®  
[Click to Enlarge](#)



Robie Sr.® 2398  
By Radio Shack®  
[Click to Enlarge](#)



Robie Sr.® 2398  
By Radio Shack®  
[Click to Enlarge](#)

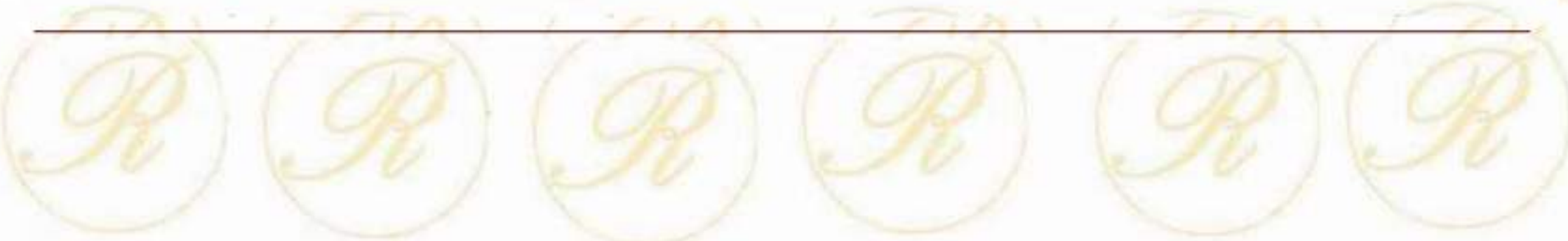

# The Old Robots Web Site

Omnibot<sup>®</sup> Robie Sr. <sup>®</sup> 2398 By Radio Shack <sup>®</sup>



Robie Sr Robot - [Click to Enlarge](#)



Robie Sr Robot - [Click to Enlarge](#)



Robie Sr Robot - [Click to Enlarge](#)



Robie Sr Robot - [Click to Enlarge](#)



Robie Sr Robot - [Click to Enlarge](#)



Robie Sr Robot - [Click to Enlarge](#)

ROBIE <sup>®</sup> SR - Radio Shack <sup>®</sup> has created toy robots throughout the years and in the 80's created a line of small personal robots. It is truly astounding what they, and other companies, were able to accomplish utilizing the resources at the time to manufacture and sell this product line. They did not have an onboard programmable computer, but the programming is done by recording the movement commands to a regular cassette tape which can be played back at certain times by using the built-in clock.

# The Old Robots Web Site

Omnibot<sup>®</sup> Robie Sr. <sup>®</sup> 2398 By Radio Shack <sup>®</sup>



INFRARED SENSOR - No. 5412

## INFRARED SENSOR - No. 5412

Ideas for your new INFRARED SENSOR accessory: Your robot can show off at yard sales, advertise specials, and carry goods on his tray: Stuck in a dark corner? Don't panic. Let your robot buddy lead the way as he steers you out of the darkness with his INFRARED SENSOR!



TRACER TAPE - No. 5413

## TRACER TAPE - No. 5413

Ideas for your new TRACER TAPE accessory: Your robot can deliver memos and secret messages and personal notes. Just plot a course to deliver routine correspondence with a tape.



PHOTO SENSOR - No. 5414

## PHOTO SENSOR - No. 5414

Ideas for your new PHOTO SENSOR accessory: Even in the dark, your Securitroid will be ready to catch a thief! Have your robot come to life just by flipping off or on a light. Your mechanical pal makes a great alarm when the sun rises!



# The Old Robots Web Site

Omnibot® Robie Sr.® 2398 By Radio Shack®



ULTRASONIC SENSOR - No. 5415

## ULTRASONIC SENSOR - No. 5415

Ideas for your new ULTRASONIC SENSOR accessory:

Amaze your friends! Hold the transmitter out of sight and your mechanical man will follow you everywhere... like magic!

Your robot can show-off at yard sales, advertises specials, and carry goods on his tray.

Let your robot race with your baby brother or sister! See who's the fastest.

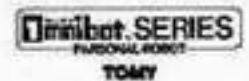

SECURITY DETECTOR - No.

## SECURITY DETECTOR - No.

Even in the dark, your Securitroid will be ready to catch a thief!



Robo Link -



Robo Link -



Robo Link -



Omnibot Microphone - Click to enlarge



Robo Link -



Robo Link -



Omnibot Microphone - Click to enlarge

## Robo Link

Robo Link for Omnibot 2000, Omnibot, and Hearoid!

# The Old Robots Web Site

Omnibot<sup>®</sup> Robie Sr.<sup>®</sup> 2398 By Radio Shack<sup>®</sup>



You can program your Omnibot<sup>®</sup> 2000, Omnibot<sup>®</sup> 5402, Hearoid<sup>®</sup> and Robie<sup>®</sup> Sr. Robots in three different ways. One is from the Robot itself, two is from a Dual Cassette Player and Recorder which is (Analog to Analog) or the third way is from a Computer to a Cassette Recorder, that is from (Digital to Analog). Of the three the first and second way is inexpensive, quick, simple and less prone to errors. The first way is contained in the users manual and is under the download page. I will show both the second and third ways here.

At the bottom of this page contain links to files that can be downloaded. This is an ongoing process and the files will be upgraded as improvements are made.

Cassette Player and Recorder Dual Track  
Analog to Analog



Information

Computer to Cassette Recorder  
Digital to Analog



Information

Computer to Robot or CD  
Computer Programming



Free Computer Program Available

Demo and Operating Program files for the Omnibot<sup>®</sup> 2000, Omnibot<sup>®</sup> 5402, Hearoid<sup>®</sup> and Robie<sup>®</sup> Sr. Robots is stored in wav format ( 1<sup>st</sup> Copy ). You can download and copy these files directly to a cassette, and use them to check your robot.

Under Construction



Omnibot<sup>®</sup>2000 - Demo Tape and  
Programing from The Old Robots - 2/1/2008

Download File Size 8.2 MB .wav



Robie<sup>®</sup>Sr. from Radio Shack<sup>®</sup> - Original  
Demo Tape and Programing - 2/1/2008

Under Construction



Omnibot<sup>®</sup>Demo Tape - Tape and  
Programing from The Old Robots - 2/1/2008

Under Construction



Hearoid<sup>®</sup>Demo Tape - Tape and  
Programing from The Old Robots - 2/1/2008

**Please give feedback to improve these Recommendations and Files for the next user.**

There is no warranty expressed or implied with this procedure. By using any information from this web site, you agree not to hold responsible this site, me, nor any of its representatives, for any injuries and/or damages, both physical and/or psychological, that may arise from the use and/or misuse of anything derived from this site. The user further agrees that such information/pictures does not constitute any guarantee of accuracy, safety or reliability, and that cannot be held responsible for any way. The user agrees to proceed at their own risk.

# The Old Robots Web Site

Omnibot<sup>®</sup> Robie Sr. <sup>®</sup> 2398 By Radio Shack <sup>®</sup>



Computer to Cassette Recorder

I have an Omnibot but lost my controller and my Omnibot<sup>®</sup> does not work without it. Not True! Download your Demo Program to check Omnibot<sup>®</sup> Robot and Operating Programs to have it work without a controller in different conditions. To program your robots you will need both hardware and software.

Omnibot<sup>®</sup> Controller Welcome! But Not Necessary. You can also make your own tapes without a controller by just downloading a program and modifying it. This is not new it has always been available but is a little used function.

A whole world has re-opened for the Omnibot<sup>®</sup> owners. You can move into a world where audio tone, sequence and timing, with simple programs on your computer, can be used to create cassette tapes. This programming will breath life into your Omnibot<sup>®</sup> and let it become your stand alone Robot.

For you to copy and edit the program tapes from your robot with your computer you must first recognize that your computer must be set up to handle audio files. Computers and there associated hardware (Video and Audio boards and drivers) do not always support the whole range with quality reproduction of your recorder programs. You need special recording software and hardware with conversion plugs and jacks for this process.

The following is recommended if you want to successfully transfer files from your audio cassette to and from your computer. Examples are shown and specific hook-up for different equipment and software will vary.



Example # 1 Mono input  
click to enlarge



Example # 2 Mono input  
click to enlarge



Example # 3 Stereo input  
click to enlarge



Example # 4  
click to enlarge

The following are some of the recommendations to copy and create programed tapes. This has been successfully done but is not always 100% successful. Follow the recommendations and the steps and you should get the same results. (Remember different computers act different.)

Please give feedback to improve these Recommendations and Files for the next user.

## SOFTWARE

- Use State of the Art Recording Technology Software
  - WavePad Recording Technology - <http://nch.com.au/wavepad/index.html>
  - &/or
  - Freecorder Recording Technology - <http://www.freecorder.com/>
- READ THE INSTRUCTIONS AND INFORMATION THAT COMES WITH THIS SOFTWARE.
- If you are recording the Omnibot Mono tape, be sure to record in Mono mode.
- A recording made with a 44100-sampling rate will carry frequencies up to 20000 Hz.
- Record and edit the tape before saving. Save only once from the original in MPG -wav format, because you lose audio quality every time you save the file.

## HARDWARE

- A good Mono or Stereo Cassette Recorder with an Auxiliary (AUX.) input.
- A high quality tape is necessary.
- The appropriate shielded plugs, jacks and cables for the recorder. The key word is shielded.
- The computer.

## PROCESS

- Computer & Recorder - Hook up the cassette recorder to the computer and test the process of recording to and from the computer.
- Omnibot<sup>®</sup> Robot - Insert a cassette tape in the Omnibot<sup>®</sup> Robot and following the instructions <sup>(1)</sup> in that manual. Record and create a programmable tape.
- Transfer the cassette to the recorder and then transfer the program to the computer with the recommended software.
- Record and edit the cassette tape on the computer and save it directly to the recorder, then save it to the computer.
- Insert the programmed cassette into the Omnibot<sup>®</sup> robot and activate using the instructions <sup>(1)</sup> that come with the Omnibot<sup>®</sup> robot.

Demo and Operating Program files for the Omnibot<sup>®</sup> 2000, Omnibot<sup>®</sup> 5402, Hearoid<sup>®</sup> and Robie<sup>®</sup> Sr. Robots is stored in wav format ( 1<sup>st</sup> Copy ). You can download and copy these files directly to a cassette tape, and use them to check your robot.

<sup>(1)</sup> Use and follow the instructions and procedures in the Omnibot<sup>®</sup> 2000, Omnibot<sup>®</sup>, Hearoid<sup>®</sup> and Robie Sr. <sup>®</sup> Operating Manuals to create your program tape.

# The Old Robots Web Site

Omnibot<sup>®</sup> Robie Sr. <sup>®</sup> 2398 By Radio Shack <sup>®</sup>

Special Thanks go to Avery Pennarun from Apenwarr, for now you can utilize several means to control the Robie Sr. <sup>®</sup> Robot. I have utilized his program to create the Computer Program and Control for the Omnibot 5402 <sup>®</sup> Robots. All of the following programs modifications/examples has been created, tested, completed, and do work.



(figure 1)

## EXAMPLES:

- a. With the Original Controller. (See the Operating Manual)
- b. Without a Controller, but with Original Tape. (Analog to Analog)
- c. Without a Controller, with original tape from the internet. (Digital to Analog)
- d. With/Without controller with computer on-line or off-line. (Computer Programming and Control - Preferred Method)

## COMBINATIONS:

- d1. With the Original Controller.
- d2. With a 49 MHz Two Way Radio. (Modifications will be necessary)  
d2-a Operating R/C frequency:  
(Remote 3 Frequencies: 49.860 Mhz (US), 27.145 Mhz (Europe), 40.680 Mhz (TAL))
- d3. With a Computer with #d1 or #d2 and/or #d4, #d5, #d6. (Software will be necessary)
- d4. With the Internal Cassette with #d1 or #d2 or #d3.
- d5. With a External Cassette with #d1 or #d2 and #d3.
- d6. With a External CD with #d1 or #d2 and #d3.
- d7. With any or all of the combinations above.

d1. With the Original Controller.

A. Robie Sr. <sup>®</sup> or Omnibot 5402 <sup>®</sup> works with his controller (figure 6). You could record a program onto a cassette tape (figure 8, 9) and play it back, and he'd do what you programmed him to. You can modify the controller and move into the world of computers and programing, without the robot activated.

d2. With a 49 MHz Two Way Radio. (figure 2, 3) (Modifications will be necessary and use of (#d3).

Note: (d2-a) Operating R/C frequency: (The Remote came in three (3) Frequencies: 49.860 Mhz (US), 27.145 Mhz (Europe), 40.680 Mhz (TAL) ). This modification does not deal with the Europe (EU) or Asia (TAL) frequencies, due to the fact that the equipment and robots was not available. However the software should work if you can obtain a Two Way Radio operating on those frequencies.

A: What to do for present day control? Get a 49 MHz Two Way Radio that broadcast and received on the same frequency as Robie Sr. <sup>®</sup> or Omnibot 5402 <sup>®</sup> to replace the original controller that will work with your robot. Add a switch and an audio jack in parallel with the microphone, so that you can switch between the two, thus allowing you to input and transmit whatever signal you want to over the airwaves to control Robie Sr. <sup>®</sup> or Omnibot 5402 <sup>®</sup>

d3. With a Computer with (#d1) or (#d2) and/or (#d4, #d5, #d6) . (Software will be necessary)

A. With the computer and software you can run to the external cassette (#d5) or the CD recorder's (#d6) (figure 4, 5) or through the original controller or the 49 MHz Two Way Radio directly to the robot, and/or to the internal cassette (#d4), or all of the above. What this gives you is the ability to create a cassette tape to the robot without the controller directly through cables and adapters (figure 7) from the computer. With the controller or the 49 MHz Two Way Radio this can bring you into the age of CD's that is readily available today and eliminate the need for the cassette. Audio cassettes are not readily available today, and not easy to hook up to a computer and connect to the internet to read and write.

Your upgrade is now complete and your next step is to downloaded a .wav recording of Robie Sr. <sup>®</sup> or Omnibot 5402 <sup>®</sup> original demo tape (it's important to use plain .wav format, as mp3 compression risks disrupting the pure signal) and burned it to a CD.

To resolve these issues you need a means of communicating, recording, playing and programming.



49 MHz FM Two Way Radio  
(figure 2)



49 MHz FM Two Way Radio  
(figure 3)



CD Player  
(figure 4)



Two Way Radio & CD Player  
(figure 5)

# The Old Robots Web Site

Omnibot<sup>®</sup> Robie Sr.<sup>®</sup> 2398 By Radio Shack<sup>®</sup>



Robie Sr.<sup>®</sup> or Omnibot 5402<sup>®</sup> Controller  
(figure 6)



Demo Tape and Cables  
(figure 7)



Cassette Tape  
(figure 8)



Cassette Recorder & Player  
(figure 9)



Cassette Recorders & Player (figure 10)

## SOFTWARE:

The software program is an extremely basic form of frequency shift keying where there is one frequency for each button on the remote control. The sound would be emitted from the remote for as long as you held down the button or pulled the joystick in a particular direction.

From the Robie Sr.<sup>®</sup> or Omnibot 5402<sup>®</sup> 1980's remote control, the control mechanism is still exactly how most remote control devices work to this day.

The remote control would form the sounds it wanted to send, then modulate them to 49 MHz FM (the usual frequency used by consumer remote control devices in the past). The robot would receive the signal, demodulate it back to listenable sounds, then recognize the different frequencies.

In the case of a tape program, it would simply skip the modulation/demodulation steps and process the sounds directly from the tape.

## Computer Controller Programs

Programming: Add a computer and software. (figure 11, 12)

Computer Control is the last step: Once you have a digital file and the ability to transmit from any audio equipment you want, the real answer is clear: computer control!

Use the application in Delphi, thanks to the TjvWavePlayer component in the awesome open source JVCL library by Avery.

After clicking the "Sound On" button, any sound from my computer can now be beamed into Robie Sr.<sup>®</sup> or Omnibot 5402<sup>®</sup>, so I can have him move around and play astonishingly - low - fidelity MP3s at people!



(figure 11)



(figure 12a)



(figure 12b)

For further information on the Robie Sr.<sup>®</sup> or Omnibot 5402<sup>®</sup> Computer Controller Conversions, please Email me.

# The Old Robots Web Site

Omnibot® Robie Sr.® 2398 By Radio Shack®



Cassette Player and Recorder Dual Track

This process uses a Dual Cassette Player and Recorder which is (Analog to Analog). This way is inexpensive, quick, simple and less prone to errors. There is a BUT You will need an Originally Recorded Cassette Tape.

Now you can program your Omnibot® and have it work without a controller. You can take a pre-existing program tape and create a second tape to run your Omnibot® Robot with new different conditions.

This process is not new, it has always been available but is a little used function. A whole world has re-opened for the Omnibot® owners.

You can move into a world where audio tone, sequence and timing, with simple editing and recording, can be used to create new program tapes that will breath life into your Omnibot® and let it become your stand alone Robot.

To program your robots you will need an original recorded cassette tape and a Dual Record and Play Cassette Player. Omnibot® Controller Welcome! But Not Necessary. Use your Demo Cassette Program to check your Omnibot® Robot and your Operating Programs to have it work without a controller.

The following are some of the recommendations to copy and create programed tapes. This has been successfully done but is not always 100% successful. Follow the recommendations and the steps and you should get the same results. (Remember different Robots and Cassette Recorders can act different.)

Please give feedback to improve these Recommendations and Files for the next user.

## SOFTWARE

- NONE IS NECESSARY
- Record from the original tape, stopping and starting the recorder, while you select from the original tape what you want to record. This will take some trial and setting until you get the experience.
- If you use software to monitor what you are doing, use State of the Art Recording Technology Software
  - WavePad Recording Technology - <http://nch.com.au/wavepad/index.html>
  - &/or
  - Freecorder Recording Technology - <http://www.freecorder.com/>
  - READ THE INSTRUCTIONS AND INFORMATION THAT COMES WITH THIS SOFTWARE.
  - If you are recording the Omnibot Mono tape, be sure to record in Mono mode.
  - A recording made with a 44100 sampling rate will carry frequencies up to 20000 Hz.

## HARDWARE

- A good Dual Mono or Stereo Cassette Player and Recorder.
- A high quality tape is necessary.
- The Omnibot® Robot in good working condition.

## PROCESS

- Cassette Player & Recorder - Hook up the cassette player and recorder, and test the process of recording between cassette tapes.
- Omnibot® Robot - Insert a cassette tape in the Omnibot® Robot and following the instructions <sup>(1)</sup> in that manual.
- Record and create a programmable tape. ( If you have a controller, if not get a tape from someone that can record and has a controller.)
- Record from the original tape, stopping and starting the recorder, while you select from the original tape what you want to record. This will take some trial and setting until you get the experience.
- Insert the programmed cassette into the Omnibot® robot and activate using the instructions <sup>(1)</sup> that come with the Omnibot®

<sup>(1)</sup> Use and follow the instructions and procedures in the Omnibot® 2000, Omnibot®, Hearoid® and Robie Sr.® Operating Manuals to create your program tape.

There is no warranty expressed or implied with this procedure. By using any information from this web site, you agree not to hold responsible this site, me, nor any of its representatives, for any injuries and/or damages, both physical and/or psychological, that may arise from the use and/or misuse of anything derived from this site. The user further agrees that such information/pictures/software does not constitute any guarantee of accuracy, safety or reliability, and that cannot be held responsible for any way. **This software is not supported.** The user agrees to proceed at their own risk.

# The Old Robots Web Site

Omnibot® Robie Sr.® 2398 By Radio Shack®



Replacement:  
Sealed Lead Acid Battery



Replacement:  
Sealed Lead Acid Battery



Original Omnibot  
Sealed Lead Acid Battery



Replacement:  
Sealed Lead Acid Battery

The above Battery is for the Tomy Robot Family. Special attention must be taken for the plug polarity.

Plugs and Jacks Polarity: Special attention must be taken for the plug polarity. (Original Equipment)



2.5 mm CO-AX Plug



Radio Shack®  
Robie Sr®  
Battery Charger 60-2398  
6VDC 400 ma

Omnibot® Series  
Omnibot® 5402;  
Hearoid;® Omnibot® MK II,  
Omnibot® 2000 5405  
TAMRANDIO® 25A-3532  
6VDC 400 ma



Replacement:  
Sealed Lead Acid Battery



Replacement:  
Sealed Lead Acid Battery



Replacement: TXR-002



Battery for TXR-002

Tomy Zenergy 6N-1201A  
6 Sanyo N-120TA ni-cad cells  
making 7.2 volts at 120mah.

The above Battery is for the Tomy Armstrong® Mobile Command Poweride - 6026 & TXR-002®. Special attention must be taken for the plug polarity.

Battery Chargers: Special attention must be taken for the plug polarity. (Original & Replacement Equipment)



Omnibot 2000  
Click to enlarge



Omnibot  
Click to enlarge



Hearoid / OOM  
Click to enlarge



Omnibot MK II  
Click to enlarge



Robie Sr.  
Click to enlarge



Omnibot Replacements  
Click to enlarge

Battery Chargers will range from 300ma to 600ma for lead acid batteries. See battery specifications and their recommendations. Special attention must be taken for the plug polarity.

# The Old Robots Web Site

Omnibot<sup>®</sup> Robie Sr. <sup>®</sup> 2398 By Radio Shack <sup>®</sup>

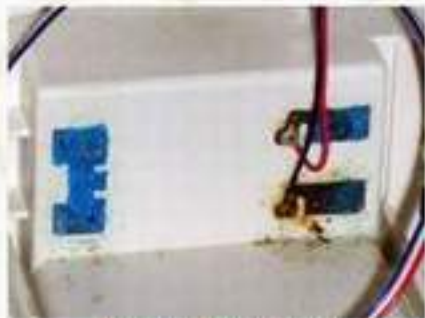

*(Before) Bad Original*

The above figure is the contacts in the Omnibot 5402 that needs to be replaced. They are corroded and not usable. (Replace)



*(After) Replacement*

The above figure is the contacts in the Omnibot 5402 that has been replaced.



*(Before) Bad Original*

The above figure is the contacts in the Omnibot 5402 that needs to be replaced. They are corroded and not usable. (Replace)



*(After) Replacement*

The above figure is the contacts in the Omnibot 5402 that has been replaced.

## Refurbished - Replacement Contact for the Omnibot Family Robots



*Bad Original (Replace)*

The following figure on the left is contacts taken from a Omnibot 5402 Controller that is corroded and not usable. It has to be replace.



*Refurbished Original*

The following figure on the left is contacts taken from a Omnibot 5402 Controller that was corroded and not usable. It has been refurbished and can now be reused.

## NEW - Replacement Contact for the Omnibot Family Robots



*Step #1*

Step #1. Omnibot 5402 contacts created from scratch. It uses contact material to create the blank.



*Step #2*

Step #2. Bend the contacts at the appropriate points



*Step #3 & #4*

Step #3. Using a punch indent the contact and then using a drill with a proper bit drill the holes in the contact.

Step #4. Heat treat the contact. You now have a finished part.

## Replaces



*Click on image*

The following figure on the left is contacts taken from a Omnibot 5402 Controller that was corroded and not usable. It has been refurbished and can now be reused.



*Click on image*

Step #1. Cut the contacts at the appropriate points



*Click on image*

Step #2. Using a punch indent the contact and then using a drill with a proper bit drill the holes in the contact. You now have a finished part.



*Click on image*

Use Brass 2/56 HEX MACH SC screws and nuts to fasten the battery contacts.



# The Old Robots Web Site

Omnibot<sup>®</sup> Robie Sr. <sup>®</sup> 2398 By Radio Shack <sup>®</sup>

## Replacing Hearoid Omnibot Battery Contacts.

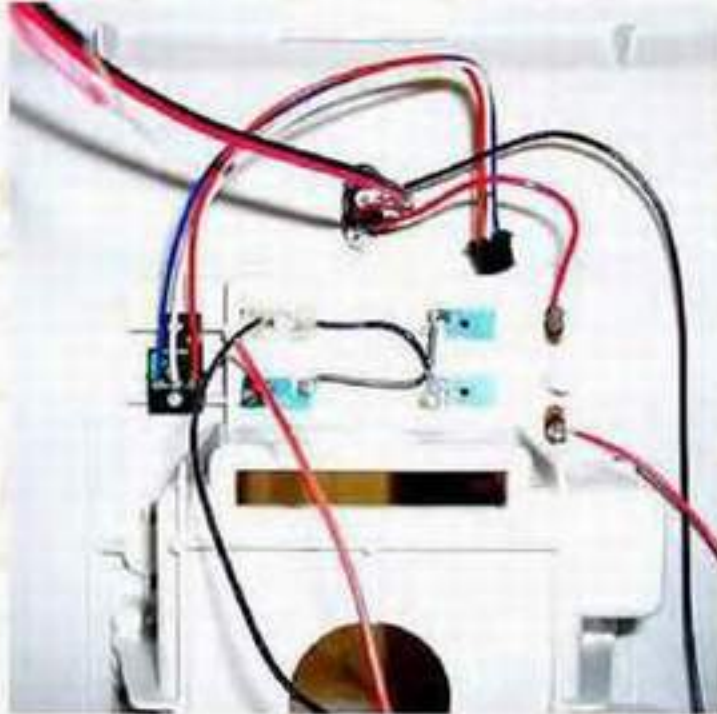

1. Check the wires to insure that you know how they are hooked up. These batteries are wired in parallel.



2. Make sure that the batteries are removed from the rear housing.



3. Place the housing flat on the table. Use a oversize drill bit and lightly drill the rim off the eye lit that hold the battery contacts in place.

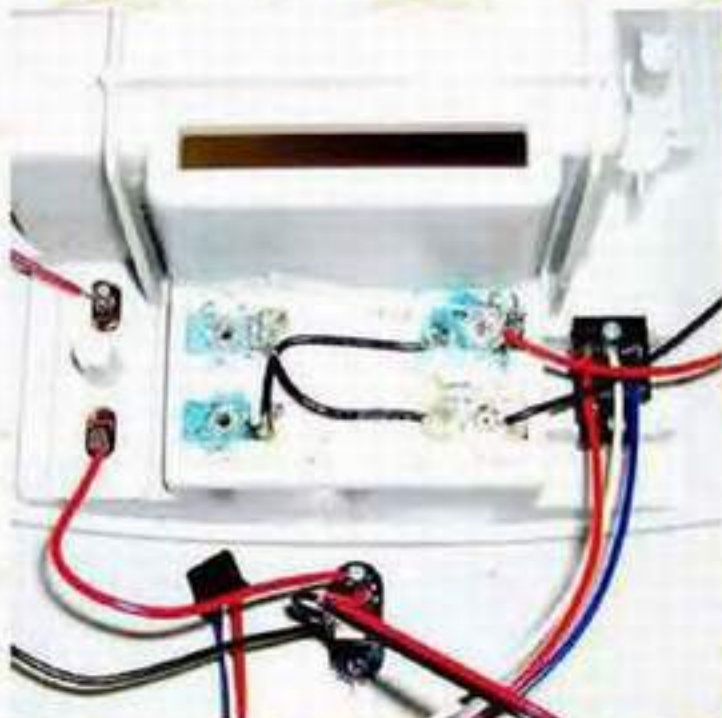

4. DO NOT drill through the battery contacts or the plastic housing.



5. Once the eye lit ridge is removed take a punch smaller than the hole and gently tap all four of the eye lit out.

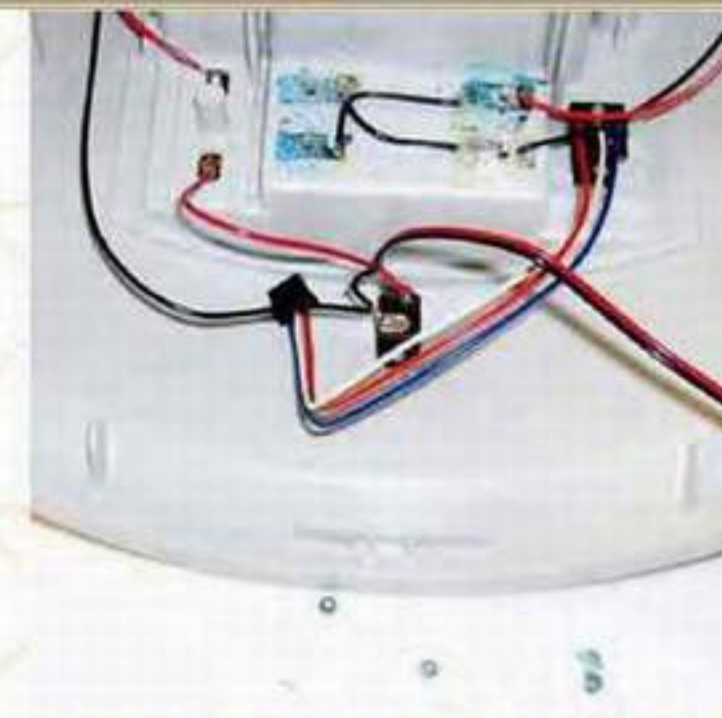

6. This picture shows the eye lit removed from the housing and battery contacts.

# The Old Robots Web Site

Omnibot<sup>®</sup> Robie Sr. <sup>®</sup> 2398 By Radio Shack <sup>®</sup>

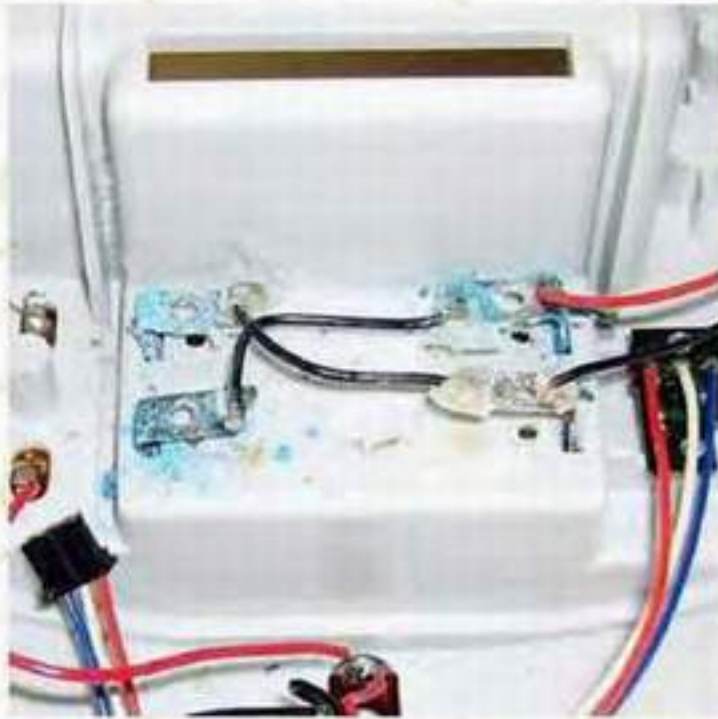

7. Gently pry the battery contacts out.

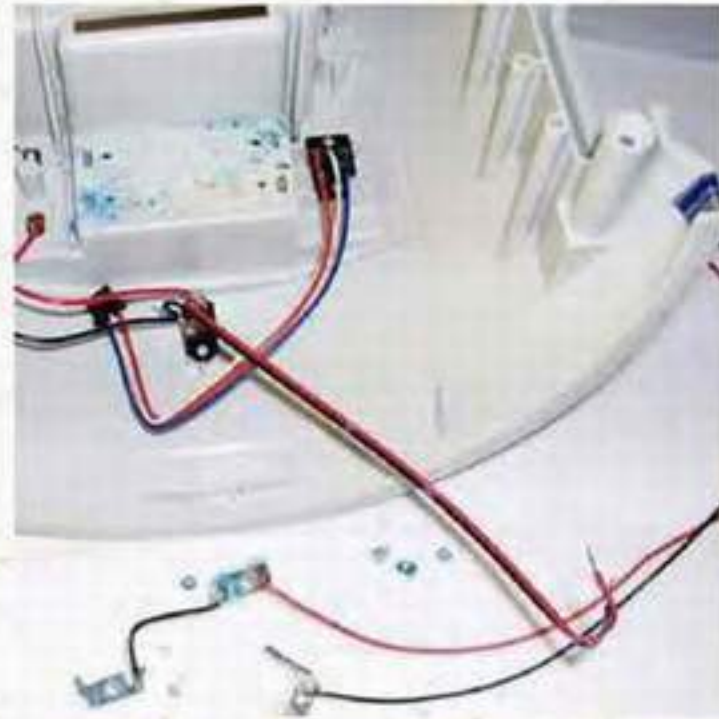

8. Remove the battery contacts and wires and plug.

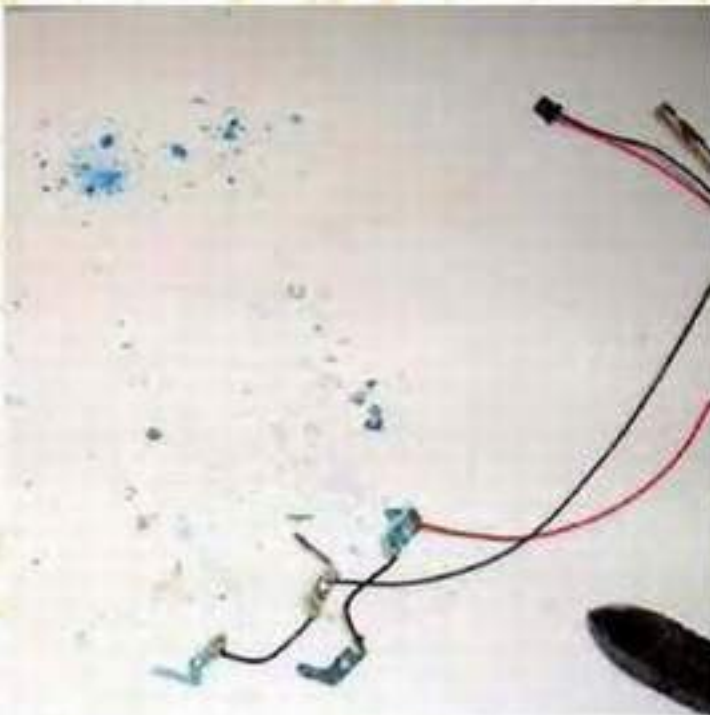

9. This is what the contacts with wire and plug will look like, Replace the battery contacts and solder the wires to the contacts.

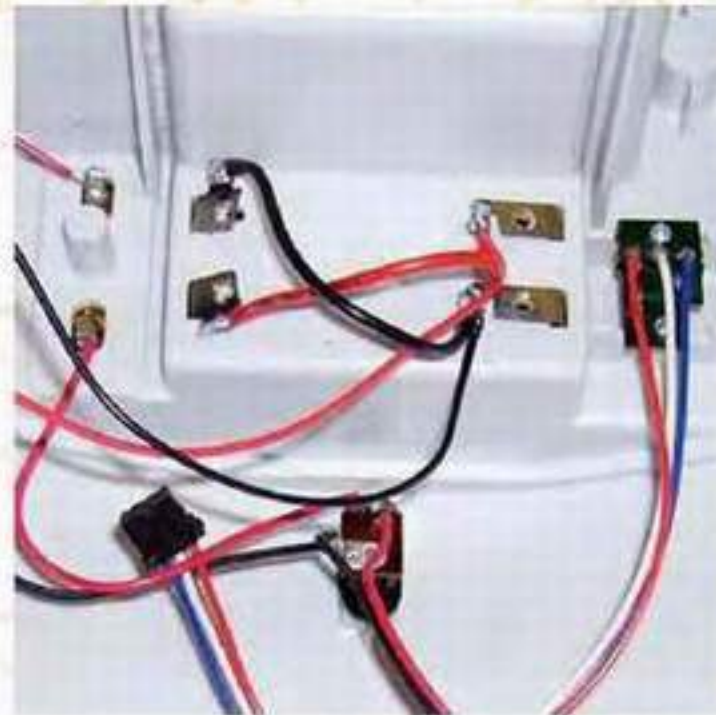

10. After cleaning the housing reinsert the new battery contacts and wires in the housing.

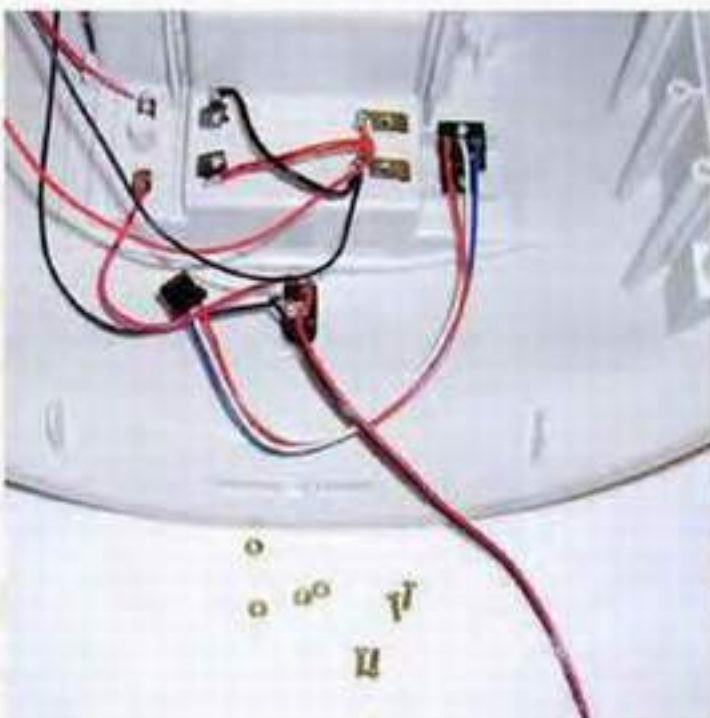

11. Use Brass 2/56 HEX MACH SC screws and nuts to fasten the battery contacts.

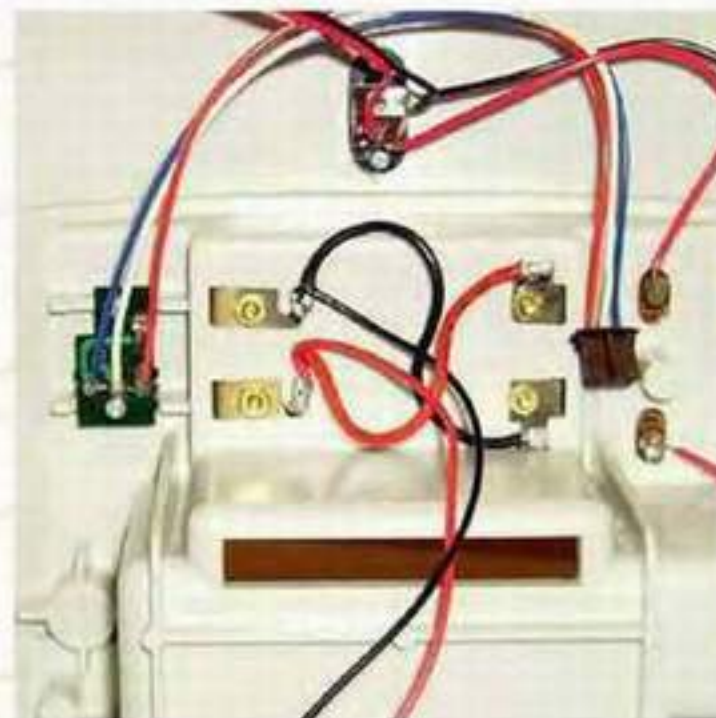

12. This is what the finished product will look like.

# The Old Robots Web Site

Omnibot<sup>®</sup> Robie Sr. <sup>®</sup> 2398 By Radio Shack <sup>®</sup>



is what the finished product will look like.



14. Install batteries into the robot housing.



15. Use a multi-meter to check conductivity both at the rear and the plug. The operation is finished.

There is no warranty expressed or implied with this procedure. By using any information from this web site, you agree not to hold responsible this site, me, nor any of its representatives, for any injuries and/or damages, both physical and/or psychological, that may arise from the use and/or misuse of anything derived from this site. The user further agrees that such information/pictures/software does not constitute any guarantee of accuracy, safety or reliability, and that cannot be held responsible for any way. **This software is not supported.** The user agrees to proceed at their own risk.

# The Old Robots Web Site

Omnibot<sup>®</sup> Robie Sr. <sup>®</sup> 2398 By Radio Shack <sup>®</sup>

BEFORE



Shown above are some examples of contacts that are in the robots and controllers. This is one reason that they do not power up.

AFTER

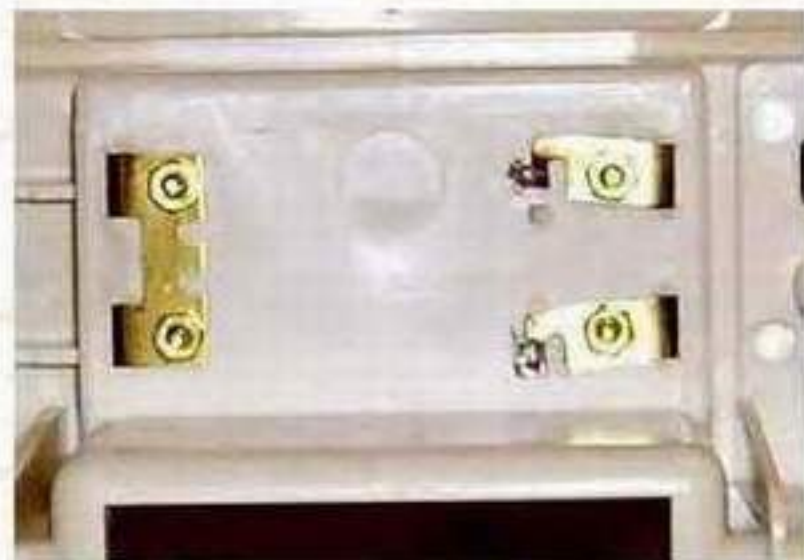

Shown above are some examples of contacts that have been replaced in the robots.

There is no warranty expressed or implied with this procedure. By using any information from this web site, you agree not to hold responsible this site, me, nor any of its representatives, for any injuries and/or damages, both physical and/or psychological, that may arise from the use and/or misuse of anything derived from this site. The user further agrees that such information/pictures/software does not constitute any guarantee of accuracy, safety or reliability, and that cannot be held responsible for any way. **This software is not supported.** The user agrees to proceed at their own risk.

# The Old Robots Web Site

Omnibot<sup>®</sup> Robie Sr. <sup>®</sup> 2398 By Radio Shack <sup>®</sup>



[Click to enlarge](#)



[Click to enlarge](#)



[Click to enlarge](#)



[Click to enlarge](#)



1. Make sure the robot is switched off. Turn the left and right ears toward the front of the robot one quarter turn. Do not force the ears because you can break off the ear tabs if they are forced.



2. Remove the faceplate and place all three parts in a safe remote place. If these parts are broken they cannot be replaced.



3. Make sure the robot is off. Open the rear door and remove the battery retainer and the large 6 V 4 AH DC rechargeable battery and the one small AA battery's. Put the door aside.



4. Turn the robot on to his back make sure that the head is free and not supporting the robot, then remove the eight screws from the bottom of the robot keeping the base and housing together. Keep these screws separate to reinstall the base.



5. Separate the bottom base slowly from the housing from the robot removing the (4) four separators.



6. Turn the base and unplug the plug from the drive box that go to the robot.

# The Old Robots Web Site

Omnibot<sup>®</sup> Robie Sr. <sup>®</sup> 2398 By Radio Shack <sup>®</sup>



7. Turn the robot in the upright position.

8. Remove the six screws from the back of the robot, and spread it apart slowly and very little (1 inch). (BE CAREFUL)

9. Separate the front from the rear housing just enough to remove the head from the housing.



10. Unplug the head and put it aside.



11. Remove the right and left arms and place them on the table.



12. Unplug the rest of the wires from the front and rear housing and separate.

**The robot is disassembled. To reassemble the robot reverse the procedure**

There is no warranty expressed or implied with this procedure. By using any information from this web site, you agree not to hold responsible this site, me, nor any of its representatives, for any injuries and/or damages, both physical and/or psychological, that may arise from the use and/or misuse of anything derived from this site. The user further agrees that such information/pictures does not constitute any guarantee of accuracy, safety or reliability, and that cannot be held responsible for any way. The user agrees to proceed at their own risk.

# The Old Robots Web Site

Omnibot<sup>®</sup> Robie Sr. <sup>®</sup> 2398 By Radio Shack <sup>®</sup>

The front and rear housings are now seperate.



## Dissassembly of the Head.



- Turn the head upside down and remove the two screws from the bottom plate.
- Using a small flat screwdriver raise the two tabs gently about 1/32 of an inch while twisting the base. Do not force the tabs as they will break off. ( These are locking tabs only)
- Remove the base.



- Turn the head upside down and remove the five screws from the bottom housing of the head.
- Separate the head housings.

There is no warranty expressed or implied with this procedure. By using any information from this web site, you agree not to hold responsible this site, me, nor any of its representatives, for any injuries and/or damages, both physical and/or psychological, that may arise from the use and/or misuse of anything derived from this site. The user further agrees that such information/pictures does not constitute any guarantee of accuracy, safety or reliability, and that cannot be held responsible for any way. The user agrees to proceed at their own risk.

# The Old Robots Web Site

Omnibot<sup>®</sup> Robie Sr. <sup>®</sup> 2398 By Radio Shack <sup>®</sup>

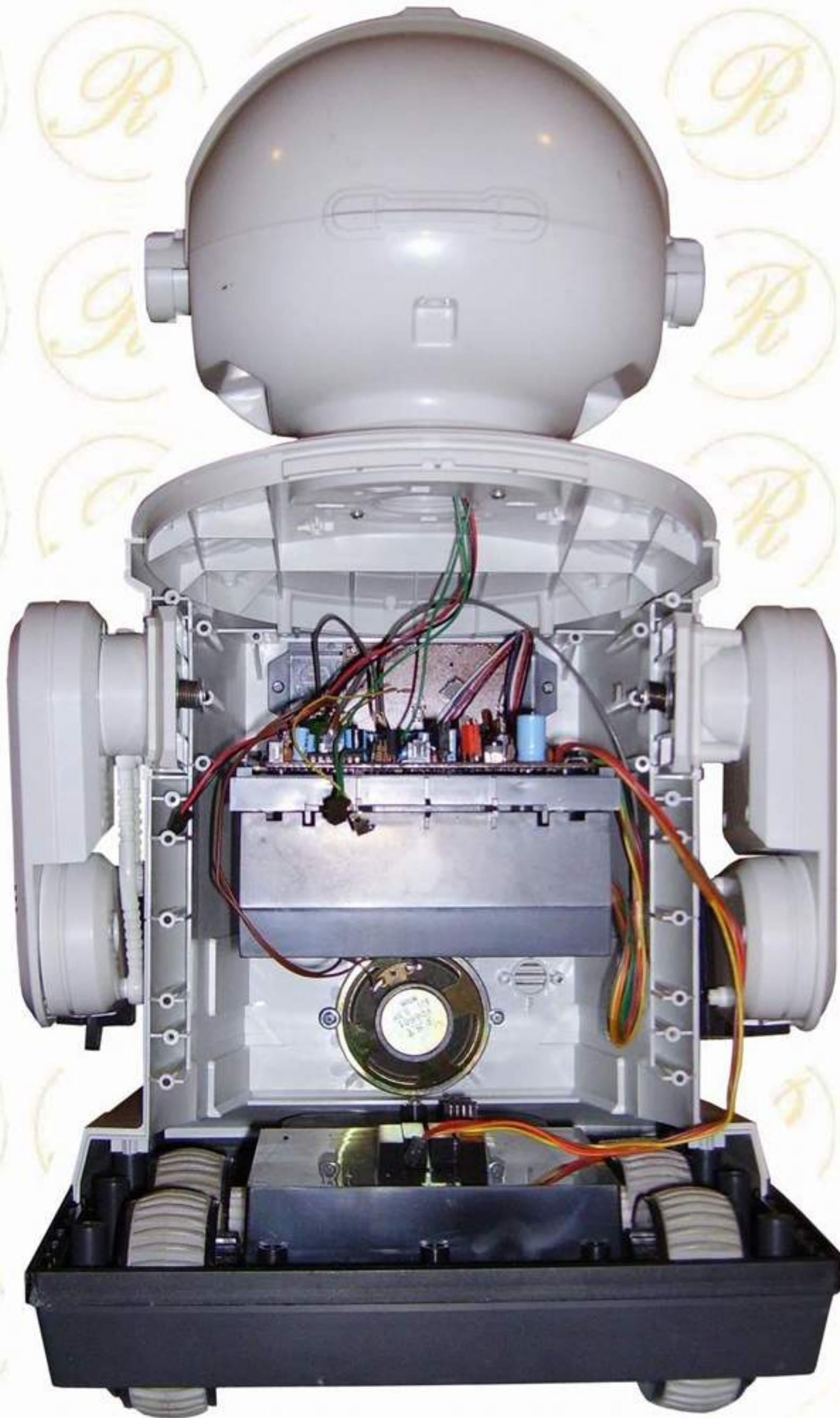



# The Old Robots Web Site

Omnibot<sup>®</sup> Robie Sr. <sup>®</sup> 2398 By Radio Shack <sup>®</sup>

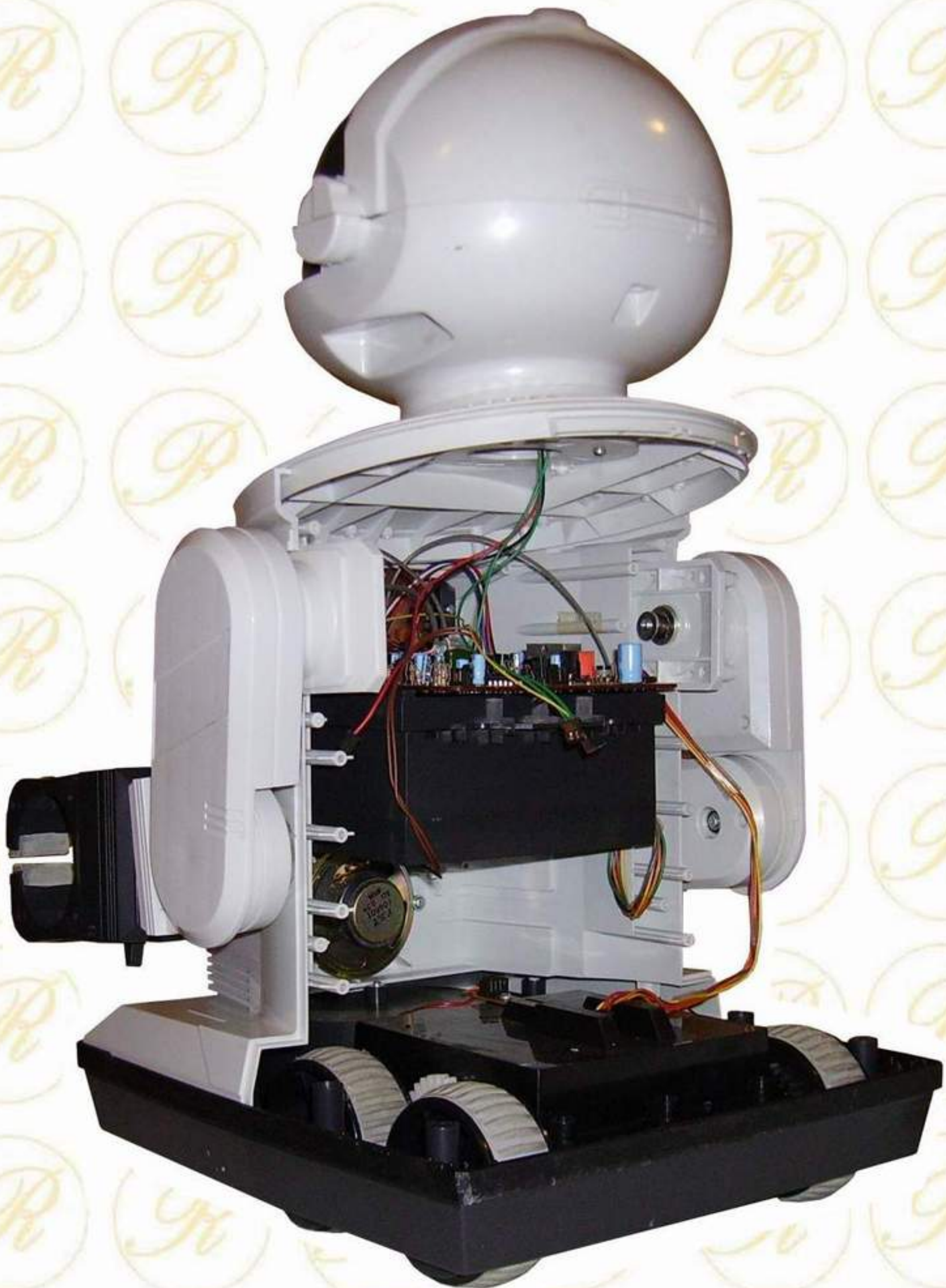



# The Old Robots Web Site

Omnibot<sup>®</sup> Robie Sr. <sup>®</sup> 2398 By Radio Shack <sup>®</sup>

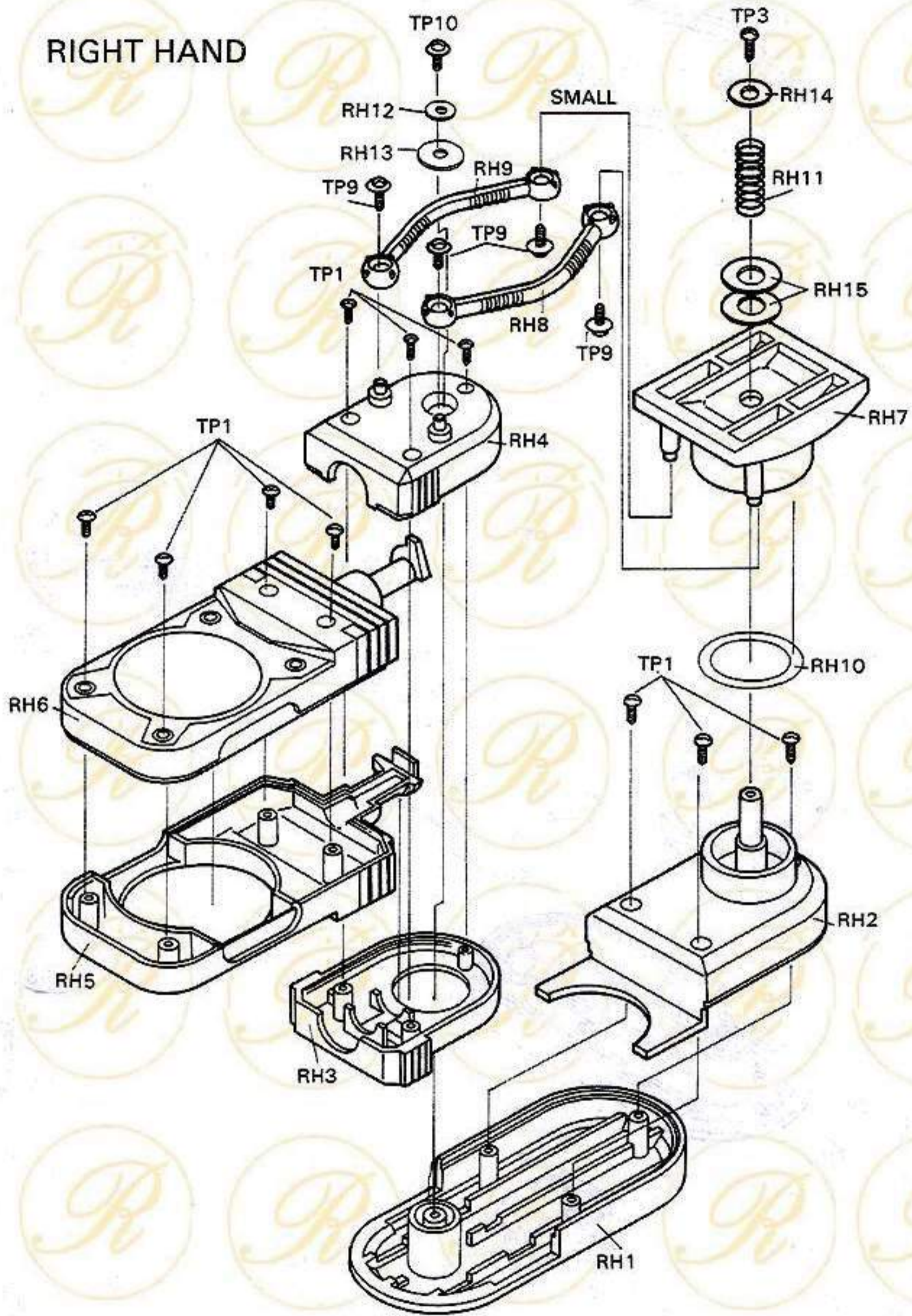

# The Old Robots Web Site

Omnibot<sup>®</sup> Robie Sr. <sup>®</sup> 2398 By Radio Shack <sup>®</sup>

LEFT HAND

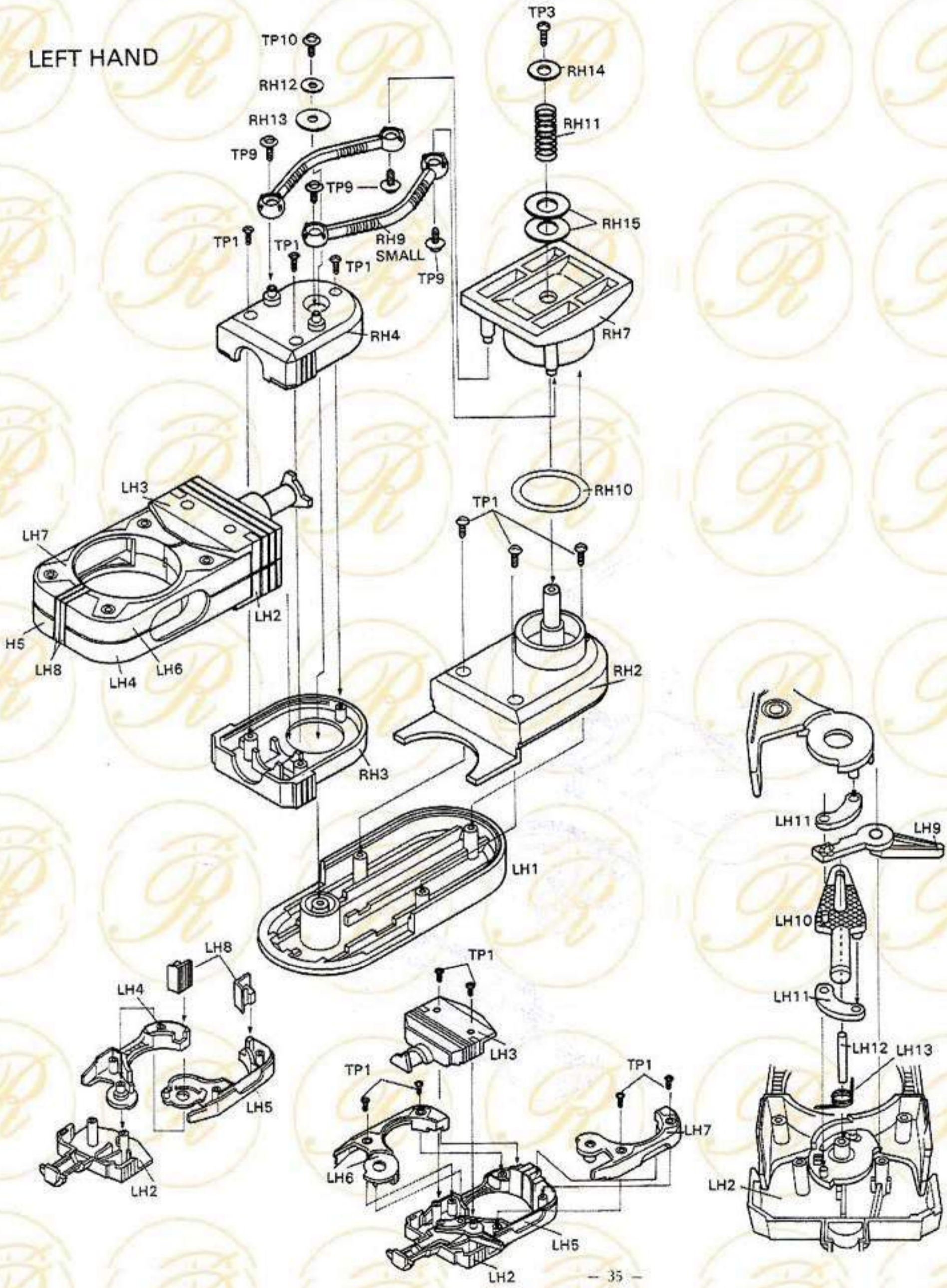

# The Old Robots Web Site

*Omnibot®2000 - Arm Circuit Board*

**ACKNOWLEDGEMENT AND APPRECIATION** - I would like to extend Acknowledgement, Appreciation and Thanks, for Permission to use the Information and Pictures to, Friends, My Mentor, Individuals, The Hobbyist Collectors (World Wide), Robot Manufactures, Robot Collectables Stores, eBay Stores, Toy Museums, Web Sites, Book Authors and News Networks, that have helped me with recommendations, encouragement, support, information and pictures for the Users of this Book and Web Sites.

To Heath®, RB Robotics®, Androbot®, TTC®, Tomy® CBS Toys,® 2001 Trendmasters, Inc.®, Radio Shack®, Clone®, Ideal® Hasbro®, and All Other Companies That Manufacture The Robots, or Companies That Claim Ownership, of pictures and information that are presented in this book or on this site. This book or site represents a presentation of my collection of robots and is for hobbyist only, and not for commercial use. It is not intended to represent your company or implied prior approval of anyone or any company, and any pictures or information that is in conflict with your company or policies, will be revised or removed when requested. I would like you to consider that the pictures and information are of both a collector and historical interest to many people. Many times when such a collector comes into ownership of one of these robots it is incomplete, they rarely obtain all of the information and material that comes with it. Without this information, they have an incomplete item.

All images, names, information, quotes or sounds used are the property of respective owners. Copyright and trademarks have been acknowledged where possible. No affiliation or endorsement has been made or taken, unless clearly indicated. Infringement is not intended. Contents will be removed if in violation. All material posted is for identification, entertainment, information, demonstration purposes and historical documentation only.

RB Robotics® Still produces the RB5X®.

Androbot® Produced the Topo®, Fred® and BOB® robots Educational and Personal Robots.

CBS Toys Produced for IDEAL™ the Electronic Maxx Steele™ Personal Robot

All Other® Companies That Manufacture The Robots, or® Companies That Claim Ownership

Heathkit® Produced the Hero®, Hero Jr®, Hero 2000® and the Hero Arm Trainer®. Formerly from Heathkit, then Mobile Ed Productions, Now Proudly brought to you by the Robot Workshop!

Tomy Co Ltd. produced the Omnibot line of robots from 1982 up until 1988 TOMY Co., Ltd. - In Japanese, K.K. Takara-Tomy Founded March 1, 2006 . Headquarters HQs in Japan, United States, United Kingdom, France, Hong Kong, Thailand. TOMY Co., Ltd. is the legal English name for the Japanese toy, children merchandise and Entertainment Company created on March 1, 2006 by the merger of "former" Tomy (Founded 1924) with Takara Co. Ltd. (Founded 1955). However, the new company made the unusual decision to adopt two different legal corporate names so while in English the name is simply TOMY, in Japanese the legal company name is the combined name, K.K. Takara-Tomy.

Tomy produced the largest robot line of the 80's. Tomy was very successful compared to other companies, and therefore many attempted to copy Tomy's robot image (decals, colours). Robots Produced not limited to, but include: Omnibot®, Omnibot® 2000, Hearoid® (TTC) , Omni® Jr. , Verbot®, Chatbot®, Crackbot®, Dustbot®, Hootbot®, Dingbot®, Flipbot®, Spotbot®

Radio Shack produced not limited to, but; include: Robie® Sr, Robie® Jr, Robie® The Talking Robot, Mobile Armatron®, Armatron®, Super Armatron®, and the Z-707 Iron Claw®

Axlon produced robots from 1984 up until 1986/7 Axlon produced a number of robots that include: Compurobot / George , Dogbot , Spybot , Talkabot. Compurobot was marketed as George in the UK by CGL but was Axlon design. The Axlon Company was founded by Nolan Bushnell (creator of Atari, Androbot Inc.) in 1984. Axlon was largely sold to Hasbro.

The pictures used are originals taken, manufactured or created from my robots, composite of pictures made by me, the manuals, instruction sheets, pictures or information sent to me, Advertisement and letters saved from the 1980,s, Magazines no longer printed, and pictures from the internet from other hobbyists.

The information contained in this book or on the site is not to be used for profit but you can copy it for personal use. You cannot claim ownership, restrict, or cause to be restricted, or change the status of any files that you download from this site. You cannot use the files for commercial use such as selling, advertising or monetary transactions. These files and pictures are free, you may use them, give them away, you cannot claim ownership restrict or sell them. When used, you must acknowledge from where the files originated.

# OmniBot

## THERE IS NO WARRANTY

By using any information from this book, you agree not to hold responsible this book, me, nor any of its representatives, for any injuries and/or damages, both physical and/or psychological, that may arise from the use and/or misuse of anything derived from this book. The user further agrees that such information/pictures does not constitute any guarantee of accuracy, safety or reliability, and that cannot be held responsible for any way. The user agrees to proceed at their own risk.

All images, names, information, quotes or sounds used are the property of respective owners. Copyright and trademarks have been acknowledged where possible. No affiliation or endorsement has been made or taken, unless clearly indicated. No payment is not intended. Contents will be removed if in violation. All material is for identification, entertainment, information, demonstration purposes and historical documentation only.

HomeMade Publishing by The Old Robot 2018 PRICE: FREE

# Companion